

HARDFACING GUIDE



Product and Procedure Selection

Selection Guide to Lincoln Hardfacing Materials and Procedures

**Lists Recommended Materials and Methods for
Hardfacing Over 200 Common Components**



Table of Contents

Section 1: Introduction

Benefits of Hardfacing	3
Build-Up and Hardfacing	3
Consumable Selection	3
Applying The Weld Deposits	4
Dependable Supply, Dependable Products	4

Section 2: Lincoln Product Data

Lincoln Hardfacing Products	5
Hardfacing Applications & Selection of Products	6
Competitive Product Comparison Charts	7-9

Section 3: Heavy Construction

Tractor Parts	10
Tractor and Shovel Parts	11
Power Shovel, Dragline Buckets and Bucket Teeth Rebuilding	12-13
Power Shovel Transmission Parts	14-15
and Ditcher Parts	
Miscellaneous Applications.....	16

Section 4: Mining

Industry Components	17-18
Mine Car Wheels	19-20
Other Mining Industry Components	21

Section 5: Crushing and Grinding

Impact Crushers Components	22-23
Other Crushing, Grinding & Screening Components.....	24

Special Feature: Hardfacing Tear-Out Chart25-26

Section 6: Cement, Brick and Clay

Cement Mill Components	27
Pulverizer Mill Components	28
Brick and Clay Manufacturing Components	29
Other Industry Components	30

Section 7: Dredging

Dredge Pump Parts	31-32
Other Dredging Parts	33

Section 8: Iron and Steel

Industry Components	34-35
Steel Mill Roll Rebuilding	36
Foundry Parts	37
Other Iron and Steel Applications	37

Section 9: Other Industries

Rubber Industry Mixing Machines	38
Railroads	39
Logging	39
Paper Pulp Digester Cladding	40
Rebuilding Tool Joints	41
Rebuilding Other Drilling Equipment	42
Other Miscellaneous Applications.....	42

Section 10: Procedures and Welding Techniques

Process Selection	43
General Guidelines	43-47
General Welding Procedures	47-49
Neutral Hardfacing Fluxes	49

Preheat Recommendation Chart50

Benefits of Hardfacing

Hardfacing is a low cost method of depositing wear resistant surfaces on metal components to extend service life. Although used primarily to restore worn parts to usable condition, hardfacing is also applied to new components before being placed into service.

In addition to extending the life of new and worn components, hardfacing provides the following benefits:

- Fewer replacement parts needed.
- Operating efficiency is increased by reducing downtime.
- Less expensive base metal can be used.
- Overall costs are reduced.

Build-up and Hardfacing

Restoring worn parts frequently involves the following three steps:

1. **Buttering** — For a deposit that will dilute the carbon and alloy content of base metal.
2. **Build-up** — Seriously worn areas should be rebuilt close to working size using tough, crack-resistant welding materials which can be deposited in an unlimited number of layers.
3. **Hardfacing** — Wear resistant surfaces deposited on the base metal or on build-up deposits extend service life. Hardfacing is usually limited to one, two, or three layers.

Consumable Selection

Welding material selection depends upon three major factors:

1. **Base Metal** — Primarily affects the choice of build-up materials.
 - a. **Manganese steel** is used for components subject to high impact loading. Rebuild to size using manganese steel weld deposits.
 - b. **Carbon and alloy steel** components are rebuilt to size using low alloy steel weld deposits.
2. **Type of Wear** — The primary consideration in selecting the final *hardfacing* layers is the type of wear to be encountered in service. These include:
 - a. **Metal-to-Metal Friction** — Wear from steel parts rolling or sliding against each other with little or no lubrication.

- b. **Severe Impact** — Wear from severe pounding which tends to squash, gouge and crack the surface. Manganese steel deposits, which work harden in service, provide the greatest impact wear resistance.
- c. **Abrasion Plus Impact** — Wear from gritty material accompanied by heavy pounding which tends to chip or crack, as well as grind, away the surface.
- d. **Severe Abrasion** — Wear from gritty materials which grind or erode the surface. Severe abrasion is often accompanied by heavy compression or moderate impact. Hard deposits are required to resist abrasion but they may also need substantial impact resistance.
- e. **Metal-to-Earth Abrasion** — Wear from earth-like materials accompanied by moderate impact (pounding.)
- f. **Corrosion** — Chemical attack.

In many, if not most cases, the effective wear is a result of a combination of two or more of the phenomena described in this section.

3. **Arc Welding Method** — The choice of arc welding method depends primarily upon the size and number of components, available positioning equipment and frequency of hardfacing. Available methods are as follows:
 - a. **Manual Welding** using stick electrodes requires the least amount of equipment and provides maximum flexibility for welding in remote locations and all positions.
 - b. **Semiautomatic Welding** uses wire feeders and self-shielded, flux-cored Lincore electrodes increasing deposition rates over manual welding.
 - c. **Automatic Welding** requires the greatest amount of initial setup, but provides the highest deposition rates for maximum productivity. It can be done with combinations of:
 - (1) Neutral flux and alloy wire.
 - (2) Alloy flux and mild steel wire.
 - (3) Self-shielded flux-cored wire with or without flux.

Applying the Weld Deposits

Cleanliness — Remove rust, dirt, grease, oil and other contaminants from the surfaces to be welded.

Surface Preparation — Badly cracked, deformed or work hardened surfaces should be removed by grinding, machining or carbon-arc gouging.

Deposit Thickness — Avoid excessive build-up of hardfacing deposits or they may crack and break off rapidly in service. If thick deposits are needed, use the appropriate build-up materials before hardfacing.

Preheat and Interpass Temperature — The combination of alloy content, carbon content, massive size and part rigidity creates a necessity to preheat in many build-up and hardfacing operations. (See the chart of recommended preheats at the end of this publication.) Slow cooling may also be needed. Low or minimum preheat, low heat input, and low interpass temperature are used on Manganese steels.

Caution — Manganese steel becomes brittle if overheated. While a 100°F to 200°F preheat may be required, do not allow interpass temperatures to exceed 500°F.

Caution — Some alloy steel components require a specific heat treatment to perform properly in service. This must be considered when preheating and welding. Contact the part maker for information.

Distortion — A small amount of distortion can destroy the usability of some parts. Rigid bracing, pre-bending, skip welding and other distortion control techniques may be required.

Welding Procedures — Obtain the recommended starting procedures from the appropriate Lincoln product literature or from procedures and techniques, etc., in this manual. The procedures and techniques listed are general guidelines for specific applications. Final responsibility must be that of the builder/user.

IMPORTANT: SPECIAL VENTILATION AND/OR EXHAUST REQUIRED

Fumes from the normal use of certain hardfacing welding products contain significant quantities of components such as chromium and manganese which can lower the 5.0 mg/m³ maximum exposure guideline for general welding fume.

BEFORE USE, READ AND UNDERSTAND THE MATERIAL SAFETY DATA SHEET (MSDS) FOR THIS PRODUCT AND SPECIFIC INFORMATION PRINTED ON THE PRODUCT CONTAINER.

Customer Assistance Policy

The business of The Lincoln Electric Company is manufacturing and selling high quality welding equipment, consumables, and cutting equipment. Our challenge is to meet the needs of our customers and to exceed their expectations. On occasion, purchasers may ask Lincoln Electric for advice or information about their use of our products. We respond to our customers based on the best information in our possession at that time. Lincoln Electric is not in a position to warrant or guarantee such advice, and assumes no liability, with respect to such information or advice. We expressly disclaim any warranty of any kind, including any warranty of fitness for any customer's particular purpose, with respect to such information or advice. As a matter of practical consideration, we also cannot assume any responsibility for updating or correcting any such information or advice once it has been given, nor does the provision of information or advice create, expand or alter any warranty with respect to the sale of our products.

Lincoln Electric is a responsive manufacturer, but the selection and use of specific products sold by Lincoln Electric is solely within the control of, and remains the sole responsibility of the customer. Many variables beyond the control of Lincoln Electric affect the results obtained in applying these type of fabrication methods and service requirements.

Dependable Supply, Dependable Products

Lincoln Electric is the world's leading manufacturer of arc welding products. With District Offices in principal U.S. cities, factory trained technical representatives, and hundreds of distributors, our sales and service cover the globe. As a special support for this distribution network, our welding technology center, located at world headquarters in Cleveland, Ohio, handles the toughest problems. This provides information and products when and where you need it — worldwide.

Product quality assurance at Lincoln Electric is a company-wide activity. Our unique incentive system gives our people a reward, and a responsibility, for producing quality electrodes.

Quality and reliability also depend on careful selection and monitoring of sources and vendors, strict process control and chemical inspection. Every incoming coil of rod must pass a comprehensive spectrographic analysis. Incoming chemicals are thoroughly tested for basic constituents and undesirable or so-called "tramp" elements. Every coating and flux mix is chemically analyzed by an x-ray fluorescence spectrometer to ensure consistent quality and formula integrity. Finished product welding tests ensure that all electrodes meet Lincoln's high standards for operator appeal.

Lincoln Hardfacing Products



BUILD-UP MATERIALS

Manual Welding	Description	Deposit Characteristics
Wearshield™ BU Wearshield BU30	<p>Weld deposits are partly ferritic and partly bainitic. Harder deposits have higher wear resistance.</p> <p>Applications</p> <p>For building up worn carbon and low alloy steel parts prior to hardfacing. Sometimes used as a final overlay on applications which require subsequent machining.</p> <p>Typical Applications:</p> <p>Tractor Rollers, Idlers, Drive Sprockets, Power Shovel Tumblers, Shafts, Trunnions, Cams, Mine Cars and Crane Wheels.</p>	<p>a. Deposit thickness unlimited. Except Lincore 33/801.</p> <p>b. As welded deposits can be machined with carbide tools if low alloy procedures and slow cooling rates are used. Harder deposits are finished by grinding or can be annealed, machined and heat-treated. Deposits are hot forgeable.</p>
<p>Semiautomatic Welding Self-Shielded, Flux-Cored Electrodes</p> <p>Lincore 33 Lincore BU Lincore 40-O Lincore BU-G</p>		
<p>Automatic Welding</p> <p>Lincore 20/801 Lincore 4130/801 Lincore 30-S/801 Lincore 8620/801 Lincore 35-S/801 H-535/L-60 (Low Alloy Procedure)</p>		

For Manganese Steel Build-Up

See "Severe Impact Materials"

METAL-TO-METAL WEAR MATERIALS

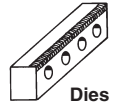
Manual Welding	Description	Deposit Characteristics
Wearshield MI Wearshield MM Wearshield T & D	<p>Weld deposits are martensitic. Harder deposits have higher wear resistance. Wearshield MI offers impact resistance.</p> <p>Applications</p> <p>To resist wear from parts rolling or sliding against each other with little or no lubrication. Where "as welded" machinability is not required.</p> <p>Typical Applications:</p> <p>Hardfacing overlay on: Tractor Rollers; Idlers and Drive Sprockets; Power Shovel Tumblers; Shafts; Trunnions; Cams; Mine Car and Crane Wheels. Brake Drums; Pinch Rolls; Coiler Rolls; Continuous Caster Rolls; Extruder Rams; Shafts; Rail ends (Wearshield MM40).</p> <p>Mine Car Wheels</p>	<p>a. Resists edge distortion and "mushrooming."</p> <p>b. Wearshield T & D and Lincore T & D have a deposit similar to a type H-12 tool steel. Both can be used to rebuild dies and metal cutting edges.</p> <p>c. Deposit thickness limited to 3 layers for Lincore 55 and H-535/L-60 and 4 layers for Lincore 40-S/801.</p> <p>d. If required, grind or anneal, machine and heat treat.</p> <p>e. Lincore 35-S, Lincore 40-S and all castor roll repair electrode deposits are readily machinable under controlled conditions.</p> <p>f. Lincore 96S, 410, 410NiMo, 420, 423L, 423Cr and 424A are used to rebuild castor rolls. See Bulletin C7.10.</p>
<p>Semiautomatic Welding Flux-Cored, Gas-Shielded & Self-Shielded Electrodes</p> <p>Lincore 33 Lincore 55-G Lincore 40-O Lincore BU-G Lincore 55 Lincore T & D</p>		
<p>Automatic Welding Flux-Cored Electrodes/Neutral Fluxes</p> <p>Lincore 32-S/802 Lincore 410/801 Lincore 33/801 Lincore 410NiMo/801 Lincore 35-S/801 Lincore 420/801 Lincore 40-S/801 Lincore 423L/802 Lincore 42-S/802 Lincore 423Cr/802 Lincore 96S/801 Lincore 424A/801 Lincore 102 HC/802 Lincore 4130/801 Lincore 102W/802 Lincore T&D/802</p>		
<p>Alloy Fluxes/Solid Electrodes</p> <p>A-96S/L-60 (420 Stainless - High Alloy Procedure)</p> <p>A-100/L-60 (410 Stainless - High Alloy Procedure)</p> <p>H-535/L-60 (High Alloy Procedure)</p>	<p>Caster Rolls</p>  <p>Idlers</p> 	<p>Dies</p> 

SEVERE ABRASION MATERIALS

Manual Welding	Description	Deposit Characteristics
Wearshield 60 Wearshield SM80 Wearshield 70	<p>The weld deposits consist of hard chromium carbide crystals in a tough matrix. Harder deposits are higher in abrasion resistance.</p> <p>Applications</p> <p>To resist wear from gritty materials like sand that grind or erode the surface. Often accompanied by heavy compression or moderate impact.</p> <p>Typical Applications:</p> <p>Scarifier teeth; grader blades; pug mill paddles; bucket lips; pulverizer jaws; screw conveyors; dredge pump casings; coal pulverizer rolls, dragline bucket sides and bottom, wear plates.</p>	<p>a. Often deposited over build-up layers of "Severe Impact" materials.</p> <p>b. Good corrosion resistance.</p> <p>c. Good high temperature [up to 1000°F (538°C) abrasion resistance. Wearshield 70 can be used up to 1400°F (760°C).</p> <p>d. Deposit thickness usually limited to 2 layers [5/16" (8mm) total]. Deposits tend to cross crack.</p> <p>e. Compression resistance of H-560/L-60, Lincore 60-O and Lincore 60-S deposit is excellent.</p> <p>f. Usually used without finishing. If required, finish by grinding. Not machinable or forgeable.</p>
<p>Semiautomatic Welding</p> <p>Lincore 60-O Lincore 65-O</p>		
<p>Automatic Welding</p> <p>Lincore 60-S/803 H-560/L-60</p>		

SEVERE IMPACT MATERIALS

Manual Welding	Description The weld deposits are austenitic (non-magnetic). Work harden when pounded in service to develop maximum hardness and wear resistance. Therefore, as welded hardness is not a measure of wear resistance. Applications To resist wear from severe pounding which tends to squash, gouge and crack the surface. Typical Applications: Dipper teeth and lips; buckets; crawler track pads and sprockets; austenitic manganese frogs and crossing diamonds; mill wobblers; dragline pins and links; crusher rolls and heads; dredge pump casings; hammers, impactor bars.	Deposit Characteristics
Wearshield 15CrMn Wearshield Mangjet® Wearshield FrogMang®		Deposit Characteristics a. Recommended for build-up of manganese steel parts. b. Deposit thickness unlimited. c. Wearshield 15CrMn and Lincore 15CrMn used for joining manganese steel to manganese steel or to carbon steel. Their deposits have excellent resistance to cracking. d. Usually used without finishing. Although machining the tough deposits is not recommended, it can be done with rigid equipment and carbide tools. Not hot forgeable.
Semiautomatic Welding Self-Shielded, Flux-Cored Electrodes		
Lincore 15CrMn Lincore M Lincore FrogMang		
Automatic Welding Flux-Cored Electrodes/Neutral Fluxes		
Lincore 15CRMnLS/803 Lincore M-1/801		

ABRASION PLUS IMPACT MATERIALS

Manual Welding	Description The weld deposits are primarily austenite with austenite – carbide eutectic. They will work harden to a limited extent when pounded in service. Hardness of the “As Welded” deposit is not a measure of wear resistance. Applications To resist wear from gritty material accompanied by heavy pounding which tends to chip or crack as well as grind away the surface. Typical Applications: Bulldozer blades; pump housings; dredge cutter teeth; tractor grousers; conveyor buckets; crusher mantles; shovel tracks; dipper teeth and lips; car shredder hammers.	Deposit Characteristics
Wearshield 44 Wearshield MI Wearshield ABR		Deposit Characteristics a. Often deposited over build-up layers of “Severe Impact” type materials. b. Deposit thickness usually limited to 2 layers (5/16" total) for Wearshield ABR or Wearshield MI, or 3 layers for Wearshield 44 or Lincore 50, deposits will tend to cross crack. c. Usually used without finishing. If required, finish by grinding or anneal, machine with carbide tools and heat treat. Deposits can be hot forged (except Lincore 50 and Wearshield MI).
Semiautomatic Welding Self-Shielded, Flux-Cored Electrodes		
Lincore 50		
Automatic Welding Flux-Cored Electrodes/Neutral Fluxes		
Lincore 50/801		

METAL-TO-EARTH ABRASION

Manual Welding	Description The weld deposits are a near-eutectic mix of austenite and carbides. Applications To resist abrasion from earth-like materials with moderate impact. Typical Applications: Dozer blades, blast furnace bells, bucket teeth	Deposit Characteristics
Wearshield 60 Wearshield ME		Deposit Characteristics a. Often deposited over build-up layers of “Severe Impact” type materials. b. Deposits cross crack. c. Deposits “scour” to a high polish for low friction. d. Not machinable or forgeable.
Semiautomatic Welding		
Lincore 50-O Lincore 60-O Lincore 60-G		
Automatic Welding Alloy Fluxes/Solid Electrodes		
H-560/L-60 (High Alloy Procedure)		

Lincoln Manual Hardfacing Comparison Charts

Stick	Build-up (Ferrite/Bainite)		Metal-to-metal (Martensite)	Metal-to-Metal (Martensite/ Austenite)	Metal-to-metal Tool Steel (Martensite)	Severe Impact (Austenite/Manganese)			Abrasion Plus Impact (Austenite/Carbide)	
	Wearshield BU	Wearshield BU30				Wearshield MM	Wearshield MI	Wearshield T&D	Wearshield Mangjet	Wearshield 15CrMn
Stoody	Build-up	Build-up LH	Multipass 22/1027	Selfharding	102-E	Dynamang, Nicomang	2110	Track Wear	77	19, 21, 31, 33
McKay	Hardalloy 32	—	Hardalloy 58	—	Hardalloy 61	Hardalloy 118	Chrome-Mang	Hardalloy 119	—	Hardalloy 40Tic, 48
Alloy Rods	3IP		4IP	5IP		Ni-Manganese	Super WH			
Bohler	Fox dur 250			Fox dur 600		Fox 12MN1-A		Fox Chromos	Fox dur 650K6	
Certanium	293, 723			267	211	298, 299	245		215,222	215, 222
Eutectic	Ferrotrode 28		N61	EUS 550	6H-SS	Eutectrode 4, 40	3205		N70	
Hobart	Smootharc 250, 320		—	600		150	MC		16	
Rankin	BU/700		Ranite BX,B	Ranite G, D		Ranmang	Ranmang 3		Ranite J	Ranite F
Rexarc	MB-35		—	48		Build-Bond	MN-100	—	55	—
Stultz Sickles	Build-up					Manganese XL	—	—	Universal HF	
Weldmold	HD 515		—	—	362	325	—	—		

NOTE: The competitive products shown are the closest equivalent to a Lincoln product and may vary in operation characteristics and performance.

Lincoln Manual Hardfacing Comparison Charts

Stick	Metal to Earth Austenitic and Eutectic Carbides	Severe Abrasions Primary Carbides	
		Wearshield 60	Wearshield 70
Lincoln	Wearshield ME		
DeLoro Stellite	35	Coated Tube Stoodite 2134	Stoodite XHC Super 20
McKay	Hardalloy 140	Hardalloy 55	Hardalloy 55Tic
Alloy Rods		40	
Bohler	Fox dur 60	Fox dur 65	
Certanium	246	230, 250	247,297
Euctectic	N6006	N6006	N6710 N6715
Hobart	35	38	45
Rankin	Ranite 4	4	—
Rexarc	60	65	—
Stultz Sickles	Ultra Hard 60	(60)	
Weldmold	358	—	—

Hardfacing Comparison Chart

Semiautomatic and Automatic Welding Products Open Arc, Self-Shielded, and Gas-Shielded

Stick	Build-up Ferritic Bainitic		Metal-to-Metal Martensitic			Metal-to-Metal Tool Steel Martensitic	Severe Impact Austenitic Manganese			Abrasion Plus Impact Austenitic and Carbides	Severe Abrasion Primary Carbides	
	Lincore BU	Lincore 33 Lincore BU-G	Lincore 40-O	Lincore 55	Lincore 55-G	Lincore T&D	Lincore M Lincore M-1	Lincore 15CrMn Lincore 15CrMnLS	Lincore Frogmang	Lincore 50	Lincore 60-0 Lincore 60-G	Lincore 65-0
Stoody	Build-up	Super Build-up	105	965	102-O 965	102G-0	Dynamang Nicromang	110	Track Wear	117, 121, 100	100HC 101HC,O,G	100HD 100XHC
McKay	BU-0	242-0	242-O	258-O		258-0	218-0	AP-0	219-0	244-0	255-0	263-0
Alloy Rods	—	Wear O Matic 3	6	—		—	Nickel Mang	Super WH		Wear O Matic 12	40	15
Certanium	—	—		246FC			—	282FC		248FC	247FC	
Eutectic	—	3010A		4415		DO-04 DO-15	3220A	3005A		4025A	4601-A	4601-A
Hobart		Build-up		960-0			150-0	MC-0		14-0	—	43-0
Rankin		Build-up	A	Ranomatic BX,D			Ranomang 2	Ranomang 3		O, F, BX-2	H	H, D
Rexarc		AS-3	A480	—			NI-MN	1414		A-11	A-01	
Stultz Sickles		Build-up	505A	50-5A			Manganese XL-SA	1616S/A		12S/A	Super 20	
Welding Alloys		T-0	P-0	WD		W-O	NM-0	AP-0		MC-0	HC-0	CN-0
Weldmold		525FC		—		958	—	—		—	—	



Hardfacing Comparison Charts

Semiautomatic and Automatic Welding Products

Submerged Arc

Sub Arc	Metal-to-Metal Thermal Fatigue and Corrosion Hi Chromium Martensite									Severe Impact Austenitic Manganese		Abrasion plus Impact Austenite and Carbides
	Lincoln Lincore 410 / 801	Lincore 410NiMo/801	Lincore 420 / 801	Lincore 96-S / 801	Lincore 424A / 801	Lincore 423L / 802	Lincore 423Cr / 802	A96S L60	A100 L60	Lincore M1 801	Lincore 15CrMn/801	
Stoody		410NiMo	420-S	4552	424	423-S	423H					117, 121 100
McKay		A2JL-S	A250-S		868-S	865-S	805-S MOD					244-S
Hobart												
Rankin												
Rexarc			A 420									
Welding Alloys			V-S				414M-S					
Alloy Rods			420S									

Sub-Arc	Build-up & Metal-To-Metal Ferritic Bainitic							Metal-to-Metal Martensitic	Metal-to-Metal Tool Steel Martensitic			
	Lincoln L-60/ H535	Lincore 8620 / 801	Lincore 4130 / 801	Lincore 20 / 801	Lincore 30-S / 801	Lincore 32-S / 801	Lincore 35-S / 801		Lincore 40-S/801	Lincore 102W / 802	Lincore 102HC / 802	Lincore T&D / 802
Stoody		8620/ Linde 50	4130	104/ Linde 50 Roll Rite Flux	104/ Linde 50 Roll Rite Flux	104TJ/ Linde 50	107/ Linde 50	105 / 105B	102 Linde 50	102S	102G	
McKay					BU-S/ Linde 50		242-S	252-S	821-S		258-S	
Hobart				Build-up S	Build-up-S			40-S	55-S	55-S		
Rankin				408	400		700	550	200			
Rexarc				AS-3	AS-3			A-17				
Welding Alloys				B-S	B-S		T-S	P-S, R-S				
Alloy Rods				3	3			8	7			

Sub-Arc	Severe Abrasion Primary Carbide			
	Lincoln Lincore 60-S / 803	Lincore 60-O / 803	Lincore 65-O / 803	L-60/ H-560
Stoody	100 HC 103		100 XHC 100HD	
McKay	255-S		263-S	
Hobart	43-S / 38-S			
Rankin	300			
Rexarc	A-650			
Welding Alloys	MC-S HC-S			

Heavy Construction

SECTION 3

Huge pieces of equipment are used to build highways, shopping centers, dams, airports, buildings and other projects. Typical example is earth moving tractors that require undercarriage and blade maintenance.

The equipment has many parts that wear from metal-to-metal friction. These parts can be restored by using Lincoln's build-up and metal-to-metal wear resistant hardfacing products.

Much of the equipment will utilize a blade or plow to move the earth. These parts can be restored by using Lincoln's abrasion plus impact, metal-to-earth or severe abrasion resistant hardfacing products.

Mining, Crushing and Grinding, and many other industries have combinations of impact and abrasion. No hardfacing material can be ideal for both. The following scale provides some guidance: **Hardfacing products for Abrasion and Impact.**



Increasing Abrasion Resistance ↑	Stick Electrodes	Wires	↓ Increasing Impact Resistance
	Wearshield 44	Lincore 40-O	
	Wearshield 60	Lincore 42-S	
	Wearshield 70	Lincore 50	
	Wearshield ABR	Lincore 55	
	Wearshield ME	Lincore 55-G	
		Lincore 60-G	
		Lincore 60-O	
		Lincore 65-O	
		Lincore T & D	

Tractor Parts

Rails

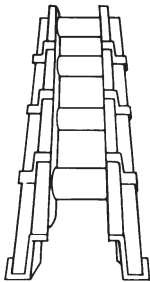

Top Carrier Rolls

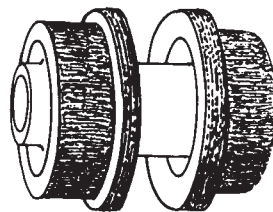

Drive Sprockets

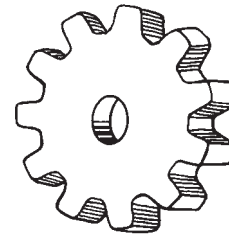

Process	for Build-Up	for Hardfacing
Manual	Wearshield BU Wearshield BU30	Wearshield MM
Semi-automatic	Lincore 33 Lincore BU-G	Lincore 33 Lincore 40-O Lincore 55 Lincore 55-G
Automatic	Lincore 20/801 Lincore 30-S/801	Lincore 30-S/801 Lincore 40-S/801 H-535/L-60 Lincore 35-S/801 Lincore 42-S/801

Comments: Most economically rebuilt using submerged arc automatic welding methods. Contact The Lincoln Electric Company for details.

Can be rebuilt for metal-to-metal wear with manual or semiautomatic methods using the materials recommended above. Start with stringer beads applied at the middle of the rail or link and work to the outside edges. Preheat is recommended.

Process	for Build-Up	for Hardfacing
Manual	Wearshield BU Wearshield BU30	Wearshield MM
Semi-automatic	Lincore 33 Lincore BU-G	Lincore 33 Lincore 40-O Lincore 55
Automatic	Lincore 20/801 Lincore 30-S/801 Lincore BU	H-535/L-60 Lincore 40-S/801 Lincore 42-S/801 Lincore 55

Comments: Prepare the rolls by cleaning the surfaces and removing bushings. Build-up with the recommended materials and add two layers of hardfacing to resist metal-to-metal wear.

When rebuilding a number of rolls automatic submerged arc welding is most economical. Contact The Lincoln Electric Company for details.

Process	for Build-Up	for Hardfacing
Manual	Wearshield BU Wearshield BU30	Wearshield MM
Semi-automatic	Lincore 33 Lincore 40-O Lincore BU-G	Lincore 55 Lincore 55-G
Comments: Rebuild the badly worn areas with the recommended build-up material, then hardface to resist metal-to-metal wear. Preheat is recommended.		

Tractor and Shovel Parts

Rollers

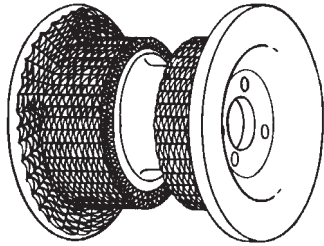

Process	for Build-Up	for Hardfacing
Manual	Wearshield BU Wearshield BU30	Wearshield MM
Semi-automatic	Lincore 33 Lincore BU-G	Lincore 33 Lincore 40-O Lincore 55 Lincore 55-G
Automatic	H-535/L-60 Lincore 30-S/801	H-535/L-60 Lincore 30-S/801 Lincore 35-S/801 Lincore 40-S/801 Lincore 42-S/801
Comments: Rebuild close to size with the appropriate build-up material and hardface for metal-to-metal wear. Automatic welding with a flux-cored electrode and submerged arc flux or a solid electrode and alloy flux provides significant savings. Preheat is recommended.		

Idlers

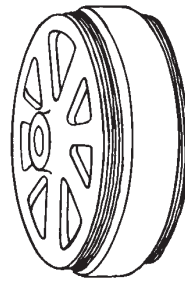

Process	for Build-Up	for Hardfacing
Manual	Wearshield BU Wearshield BU30	Wearshield MM
Semi-automatic	Lincore 33 Lincore BU-G	Lincore 33 Lincore 40-O Lincore 55 Lincore 55-G
Automatic	H-535/L-60 Lincore 30-S/801	H-535/L-60 Lincore 35-S/801 Lincore 40-S/801 Lincore 42-S/801
Comments: Build the idlers to size and hardface with the recommended materials. Automatic submerged arc welding is most economical. Either stringer or transverse beads can be applied. Preheat is recommended.		

Shovel Rollers

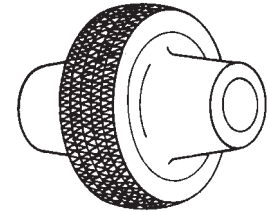

Process	for Build-Up	for Hardfacing
Manual	Wearshield BU Wearshield BU30	Wearshield MM
Semi-automatic	Lincore 33 Lincore BU-G	Lincore 33 Lincore 40-O Lincore 55 Lincore 55-G
Automatic	H-535/L-60 Lincore 30-S/801	H-535/L-60 Lincore 35-S/801 Lincore 40-S/801 Lincore 42-S/801
Comments: Rebuild with the recommended material. When manual welding one layer of Wearshield MM adds metal-to-metal wear resistance. Preheat is recommended.		

Drive Tumblers

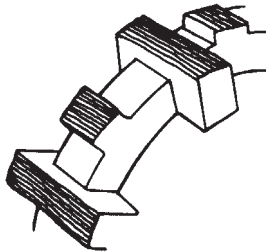

Base Metal: Carbon Steel		
Process	for Build-Up	for Hardfacing
Manual	Wearshield BU Wearshield BU30	Wearshield MM
Semi-automatic	Lincore 33 Lincore BU-G	Lincore 33 Lincore 40-O Lincore 55 Lincore 55-G
Base Metal: Manganese Steel		
Process	for Build-Up	for Hardfacing
Manual	Wearshield 15CrMn Wearshield Frogmang Wearshield Mangjet	Wearshield 15CrMn Wearshield Frogmang Wearshield Mangjet
Semi-automatic	Lincore 15CrMn Lincore Frogmang Lincore M	Lincore 15CrMn Lincore Frogmang Lincore M
Comments: Rebuild to size using the recommended material appropriate for the base metal and method. One layer of Wearshield MM can be added to carbon-steel tumblers manually for better metal-to-metal wear.		

Track Pads

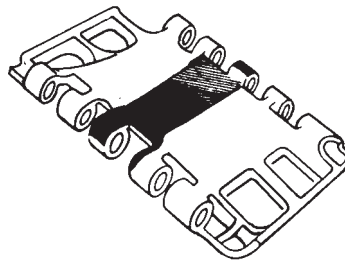

Base Metal: Carbon Steel		
Process	for Build-Up	for Hardfacing
Manual	Wearshield BU Wearshield BU30	Wearshield MM
Semi-automatic	Lincore 33 Lincore BU-G	Lincore 40-O Lincore 55 Lincore 55-G
Automatic	H-535/L-60 Lincore 30-S/801	H-535/L-60 Lincore 40-S/801 Lincore 42-S/801 Lincore 55/801
Base Metal: Manganese Steel		
Process	for Build-Up	for Hardfacing
Manual	Wearshield 15CrMn Wearshield Mangjet	Wearshield 15CrMn Wearshield Mangjet
Semi-automatic	Lincore 15CrMn Lincore M	Lincore 15CrMn Lincore Frogmang Lincore M
Comments: Rebuild pads to size and hardface with materials recommended for the base metal. Special ventilation and/or exhaust may be required.		

Boom Heels

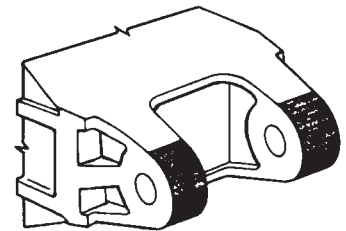

Base Metal: Carbon Steel		
Process	for Build-Up	for Hardfacing
Manual	Wearshield BU Wearshield BU30	Wearshield MM
Semi-automatic	Lincore 33 Lincore BU-G	Lincore 33 Lincore 40-O Lincore 55 Lincore 55-G
Base Metal: Manganese Steel		
Process	for Build-Up	for Hardfacing
Manual	Mangjet Wearshield Wearshield 15CrMn	Wearshield 15CrMn Wearshield Mangjet
Semi-automatic	Lincore 15CrMn Lincore M	Lincore 15CrMn Lincore M
Comments: Rebuild to size using the material recommended for the base metal and welding method. Hardface to resist metal-to-metal wear.		

Power Shovel and Dragline Buckets and Bucket Teeth Rebuilding

Whether removing earth overburden prior to excavating for coal or minerals, or building highways or other construction projects, power shovel buckets and bucket teeth are subjected to varying degrees of abrasion and impact. Some types of sandy soils are very abrasive but do not provide much in the way of impact wear. Rocky soils are not only abrasive but provide moderate to heavy impact wear. The type of wear involved will indicate the type of hardfacing materials to be used.

Bucket Teeth

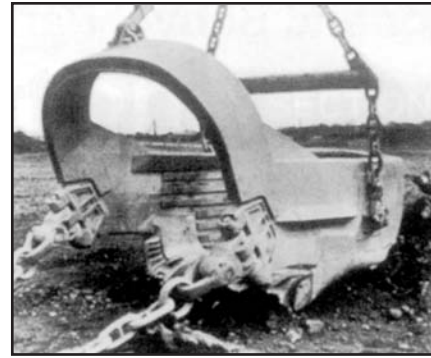
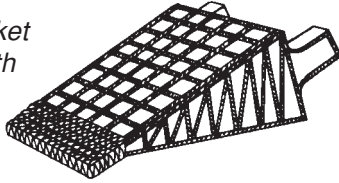

Hardfacing Weld Bead Placement

Build-up top and sides of teeth solid from tip back 2" (50mm). Also put beads of hardfacing material all the way around periphery of teeth. Place balance of beads to resist type of service involved:

Type of Tooth	Welding Process	Build-Up Material	For Dirt or Clay	For Sand	For Rock or Slag	For Both Rock and Sand or Dirt
			Metal-to-Earth Abrasion	Severe Abrasion	Abrasion and Impact	Abrasion and Impact
Manganese Steel	Manual	Wearshield 15CrMn Wearshield Frogmang Wearshield Mangjet	Wearshield ME	Wearshield 60 Wearshield 70	Wearshield 44 Wearshield ABR Wearshield ME	Wearshield 44 Wearshield ABR Wearshield ME
	Semiautomatic	Lincore 15CrMn Lincore Frogmang Lincore M	Lincore 60-O Lincore 65-O	Lincore 60-O Lincore 65-O	Lincore 50	Lincore 50
Carbon or Alloy Steel	Manual	Wearshield BU Wearshield BU30	Wearshield ME	Wearshield 60 Wearshield 70	Wearshield 44 Wearshield ABR Wearshield ME	Wearshield 44 Wearshield ABR Wearshield ME
	Semiautomatic	Lincore 33 Lincore BU-G	Lincore 60-O Lincore 65-O	Lincore 60-O Lincore 65-O	Lincore 50	Lincore 50

Bucket Lips and Bodies

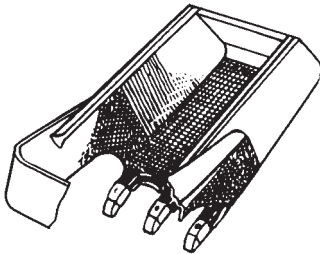

Hardfacing Weld Bead Placement

Hardface top of leading edge of bucket lip solid from tip back approximately 2" (50mm). Place balance of beads to resist type of service involved.

For Dirt, Clay or Sand	For Rock or Slag	For Both Rock and Sand or Dirt
Place beads perpendicular to material flow	Place beads parallel to material flow	Use waffle pattern

NOTE: Use welding materials comparable to those recommended for Bucket Teeth.

General Recommendations

- I. Applying applicator bars to teeth.
 - A. Trim front of tooth square by flame cutting.
 - B. Weld applicator bar to tooth.
 1. Manganese bars and teeth.
 - a. Use Wearshield 15CrMn manual electrode or Lincore 15CrMn semiautomatic wire.
 2. Carbon or alloy steel bars to carbon or alloy steel teeth. Use Lincoln low hydrogen mild steel manual electrode (E7018) or Innershield NS-3M (E70T-4) semiautomatic wire.
 - C. Hardface applicator bar and weld deposit joining bar to tooth.
 - a. Use hardfacing materials recommended above.

- II. Recommended preheat and interpass temperatures for welding bucket teeth, lips and bodies.
 - A. Never overheat Manganese steel. Keep Interpass Temperatures below 500°F (260°C)

- Manganese steel is non-magnetic.** (Check with magnet).
- B. Carbon and/or Alloy Steels — check preheat chart to determine recommended preheat and interpass Temperature or use Lincoln Preheat Calculator to determine proper preheat based upon chemical analysis along with thickness of heavier part being welded.

Bucket Tooth Adapters

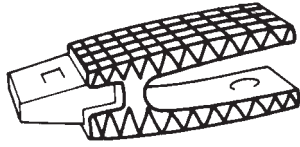

Base Metal: Carbon Steel		
Process	for Build-Up	for Hardfacing
Manual	Wearshield BU Wearshield BU30	Wearshield 44
		Wearshield 60 Wearshield ABR Wearshield ME
Semi-automatic	Lincore 33 Lincore BU-G	Lincore 50
		Lincore 60-O Lincore 60-G
Base Metal: Manganese Steel		
Process	for Build-Up	for Hardfacing
Manual	Wearshield 15CrMn Wearshield Frogmang Wearshield Mangjet	Wearshield 44
		Wearshield 60
		Wearshield ABR Wearshield ME
Semi-automatic	Lincore 15CrMn Lincore Frogmang Lincore M	Lincore 50
		Lincore 60-G Lincore 60-O
<p>Comments: Cover the entire surface with stringer beads in a cross hatch pattern as shown. Use Wearshield 60 or Lincore 60-O for severe abrasion; Wearshield ABR or Lincore 50 for better impact resistance.</p> <p>Use Wearshield ME for abrasion with moderate impact.</p>		

Dragline Chains

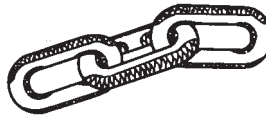

Base Metal: Carbon Steel		
Process	for Build-Up	for Hardfacing
Manual	Wearshield BU Wearshield BU30	Wearshield 44
		Wearshield 60 Wearshield ABR Wearshield MM
Semi-automatic	Lincore 33 Lincore BU-G	Lincore 50
		Lincore 55 Lincore 55-G Lincore 60-G Lincore 60-O
Base Metal: Manganese Steel		
Process	for Build-Up	for Hardfacing
Manual	Wearshield 15CrMn Wearshield Frogmang Wearshield Mangjet	Wearshield MM
		Wearshield ABR
		Wearshield 44 Wearshield 60
Semi-automatic	Lincore 15CrMn Lincore Frogmang Lincore M	Lincore 50
		Lincore 55 Lincore 55-G Lincore 60-G Lincore 60-O
<p>Comments: Rebuild the link-to-link wear areas with the material recommended for the base metal and welding method. Hardface this area for metal-to-metal wear using Wearshield MM or Lincore 55. Hardface the outside wear areas to resist severe abrasion using Wearshield 60, Lincore 60-O or Lincore 50.</p>		

Dragline Clevis

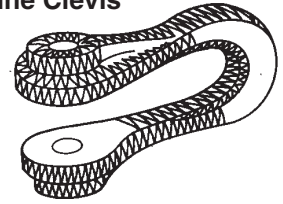

Base Metal: Carbon Steel		
Process	for Build-Up	for Hardfacing
Manual	Wearshield BU Wearshield BU30	Wearshield 60
		Wearshield MM
Semi-automatic	Lincore 33 Lincore BU-G	Lincore 50
		Lincore 55 Lincore 55-G Lincore 60-G Lincore 60-O
Base Metal: Manganese Steel		
Process	for Build-Up	for Hardfacing
Manual	Wearshield 15CrMn Wearshield Frogmang Wearshield Mangjet	Wearshield ABR
		Wearshield MM
		Wearshield 60
Semi-automatic	Lincore 15CrMn Lincore Frogmang Lincore M	Lincore 50
		Lincore 55 Lincore 55-G Lincore 60-G Lincore 60-O
<p>Comments: Rebuild the link-to-link clevis wear areas with the material recommended for the base metal and welding method. Hardface this metal-to-metal wear area using Wearshield MM or Lincore 55. Hardface the outside wear areas to resist abrasion using Wearshield ABR, Wearshield 60, Lincore 50 or Lincore 60-O.</p>		

Dragline Pins

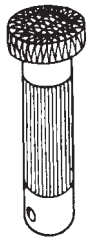

Process	for Build-Up	for Hardfacing
Manual	BU 30	Wearshield 60
		Wearshield ME Wearshield MM
Semi-automatic	Lincore 33 Lincore BU-G	Lincore 55
		Lincore 55-G Lincore 60-G Lincore 60-O
<p>Comments: Hardface the end of the pin to resist severe abrasion using Wearshield 60. Hardface the bearing area to resist metal-to-metal wear using Wearshield MM.</p>		

Cable Sheaves

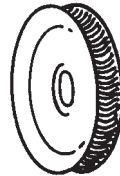

Process	for Build-Up	for Hardfacing
Manual	Wearshield BU Wearshield BU30	Wearshield MM
Semi-automatic	Lincore 33 Lincore 60-G Lincore BU-G	Lincore 33
		Lincore 40-O Lincore 55 Lincore 55-G
Automatic	H-535/L-60 Lincore 30-S/801 Lincore 4130/801	H-535/L-60
		Lincore 30-S/801 Lincore 35-S/801 Lincore 40-S/801 Lincore 42-S/801 Lincore 102HC/802 Lincore 102W/802 Lincore 4130/801
<p>Comments: With circumferential beads, bring the worn areas up to size. Select either Lincore BU flux-cored electrode or H-535 alloy flux or Lincore 4130/801 with flame hardening.</p>		

Latch Plates and Bars

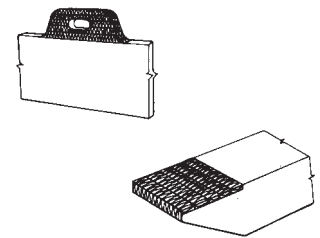

Base Metal: Carbon Steel		
Process	for Build-Up	for Hardfacing
Manual	Wearshield BU Wearshield BU30	Wearshield MM
Semi-automatic	Lincore 33 Lincore BU-G	Lincore 40-O
		Lincore 55 Lincore 55-G
Base Metal: Manganese Steel		
Process	for Build-Up	for Hardfacing
Manual	Wearshield 15CrMn Wearshield Frogmang Wearshield Mangjet	Wearshield MM
Semi-automatic	Lincore 15CrMn Lincore Frogmang Lincore M	Lincore 50
		Lincore 55 Lincore 55-G
<p>Comments: Rebuild to size using the material recommended for the base metal and welding method. Hardface to resist metal-to-metal wear.</p>		

Power Shovel Transmission Parts

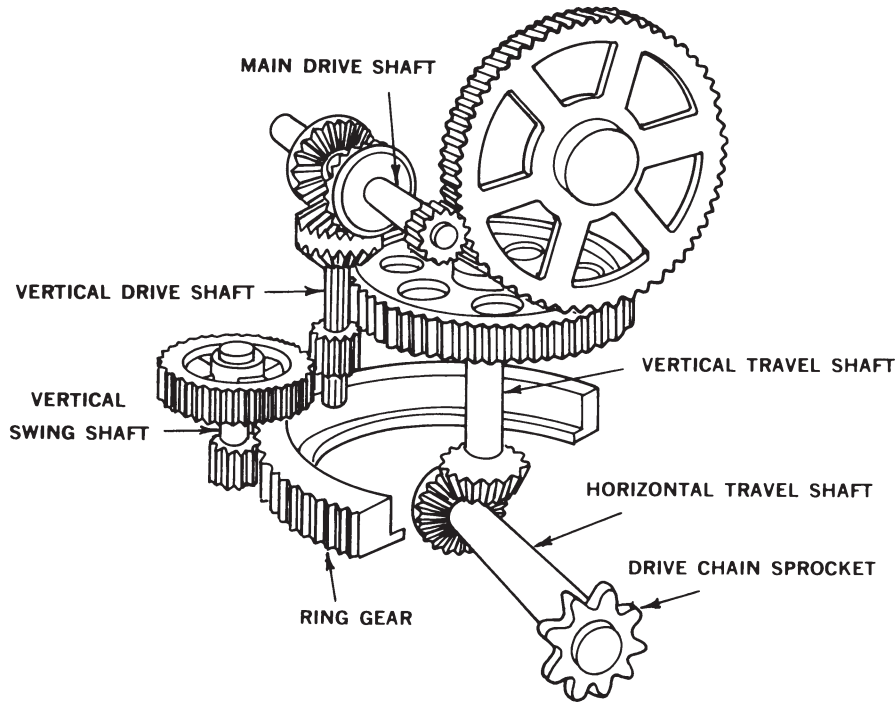

Gears		
Process	for Build-Up	for Hardfacing
Manual	—	Wearshield BU Wearshield BU30
Semi-automatic	—	Lincore 33 Lincore 40-O Lincore BU-G
Automatic	—	Lincore 20/801 Lincore 30-S/801

Comments: Many of the gears can be restored by arc welding. Rebuild worn gears with build-up materials, Wearshield BU30 or Lincore 33. Large house ring gears can be rebuilt with automatic submerged arc welding. Use the proper preheat and postheat to prevent cracking and distortion. Grind to finish mating surfaces.

Shafts		
Process	for Build-Up	for Hardfacing
Manual	—	Wearshield BU Wearshield BU30
Semi-automatic	—	Lincore 33 Lincore 40-O Lincore BU-G
Automatic	—	Lincore 20/801 Lincore 30-S/801

Comments: Worn shafts are most economically rebuilt with automatic submerged arc welding using Lincore 30-S flux-cored electrode and 801 flux. Use the proper preheat and interpass temperatures. Finish by machining.

Ditcher Parts

Drive Segments

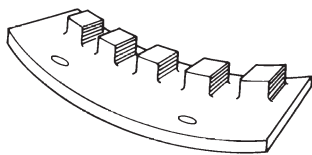

Process	for Build-Up	for Hardfacing
Manual	Wearshield BU Wearshield BU30	Wearshield MM
Semi-automatic	Lincore 33 Lincore BU-G	Lincore 33 Lincore 40-O Lincore 55 Lincore 55-G
Comments: Using manual welding, rebuild worn areas close to size using Wearshield BU or Wearshield BU30 electrode. Hardface with Wearshield MM to resist metal-to-metal wear. Finish grinding to obtain the desired shape.		

Rolls

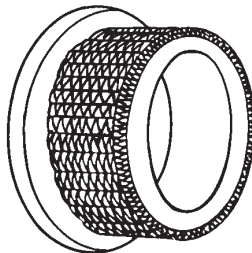

Process	for Build-Up	for Hardfacing
Manual	Wearshield BU Wearshield BU30	Wearshield MM
Semi-automatic	Lincore 33 Lincore BU-G	Lincore 33 Lincore 40-O Lincore 55 Lincore 55-G
Automatic	H-535/L-60 Lincore 20/801 Lincore 30-S/801	H-535/L-60 Lincore 35-S/801 Lincore 40-S/801 Lincore 42-S/801
Comments: Rebuild close to size and hardface for metal-to-metal wear using the materials recommended for manual, semiautomatic or automatic welding as appropriate.		

Drive Sprockets

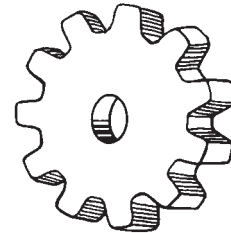

Process	for Build-Up	for Hardfacing
Manual	Wearshield BU Wearshield BU30	Wearshield BU
Semi-automatic	Lincore 33 Lincore BU-G	Lincore 33 Lincore BU-G
Comments: Rebuild to size using Wearshield BU or Wearshield BU30 manual electrode. Finish grinding may be required for mating surface.		

Dozer End Bits



Process	for Build-Up	for Hardfacing
Manual	—	Wearshield 44 Wearshield 60 Wearshield ABR Wearshield ME
Semi-automatic	—	Lincore 50 Lincore 60-G Lincore 60-O Lincore 65-O
Automatic	—	H-560/L-60 Lincore 50/801 Lincore 60-S/803 Lincore 65-O
<p>Comments: When working in severe abrasive applications hardface use Wearshield 60 manual electrode or Lincore 60-O, Lincore 60-S semiautomatic electrodes. For conditions requiring more impact resistance use Wearshield ABR or Wearshield 44 electrode or Lincore 50 semiautomatic wire. The parts can also be hardfaced using H-560 alloy submerged arc flux or Lincore 60-S with 803 flux.</p>		

Dozer Blades

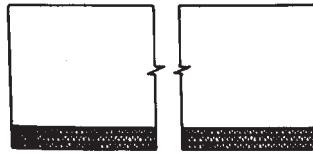

Process	for Build-Up	for Hardfacing
Manual	—	Wearshield 44 Wearshield 60 Wearshield ABR Wearshield ME
Semi-automatic	—	Lincore 50 Lincore 60-G Lincore 60-O Lincore 65-O
Automatic	—	Lincore 60-S/803 Lincore 65-O
<p>Comments: Deposit stringer beads. Use Wearshield 60, Lincore 60-O or Lincore 60-S/803 for severe and continuous abrasive wear; Wearshield ABR, Wearshield 44 or Lincore 50 when some impact resistance is needed.</p>		

Ripper Teeth

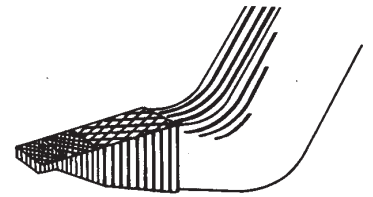

Process	for Build-Up	for Hardfacing
Manual	—	Wearshield 44 Wearshield 60 Wearshield ABR Wearshield ME
Semi-automatic	—	Lincore 50 Lincore 60-G Lincore 60-O Lincore 65-O
Automatic	—	H-560/L-60 Lincore 60-S/803 Lincore 65-O
<p>Comments: Hardface the entire wear area. Use Wearshield 60 or Lincore 60-O in severely abrasive soil. Where better impact resistance is required use Lincore 50, Wearshield 44 or Wearshield ABR. Automatic submerged arc methods using H-560 flux and L-60 electrode or Lincore 60-S/803 flux provide economies when rebuilding volumes of teeth for severely abrasive soil.</p>		

Scraper Cutters and Sides

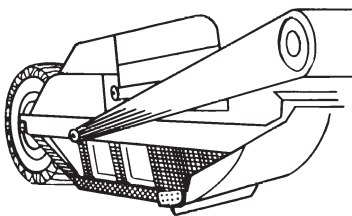

Process	for Build-Up	for Hardfacing
Manual	—	Wearshield 44 Wearshield 60 Wearshield ABR Wearshield ME
Semi-automatic	—	Lincore 50 Lincore 60-G Lincore 60-O Lincore 65-O
Automatic	—	Lincore 60-S/803
<p>Comments: In conditions of severe abrasion use Wearshield 60 manual electrode, Lincore 60-O or Lincore 60-S semiautomatic electrodes. When moderate impact accompanies abrasion use Wearshield ABR, Wearshield 44 or Lincore 50.</p>		

Grader Blades

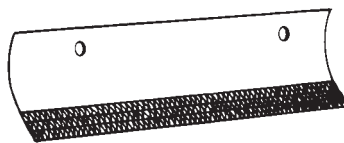

Process	for Build-Up	for Hardfacing
Manual	—	Wearshield 44 Wearshield 60 Wearshield ABR Wearshield ME
Semi-automatic	—	Lincore 50 Lincore 60-G Lincore 60-O Lincore 65-O
Automatic	—	Lincore 60-S/803
<p>Comments: Apply proper preheat. Hardface the blade with the materials recommended for the welding method to be used. Take the needed precautions to prevent distortion.</p>		

Scoop Lift Buckets

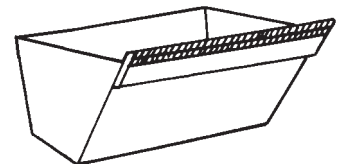

Process	for Build-Up	for Hardfacing
Manual	—	Wearshield 44 Wearshield ABR Wearshield M-1 Wearshield ME
Semi-automatic	—	Lincore 50 Lincore 60-G Lincore 60-O Lincore 65-O
Automatic	—	Lincore 50/801 Lincore 60-S/803
<p>Comments: Use Wearshield ABR, Wearshield MI or Lincore 50 to deposit a moderate abrasion/moderate impact resistant deposit on the underside of the lip as shown.</p>		

Miscellaneous Applications

Asphalt Mixer Paddles

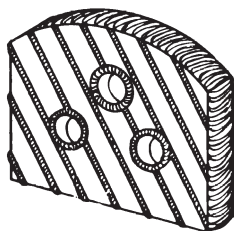

Process	for Build-Up	for Hardfacing
Manual	—	Wearshield 60 Wearshield 70
Semi-automatic	—	Lincore 60-G Lincore 60-O Lincore 65-O

Comments: To resist the severe abrasive wear use Wearshield 60 depositing a pattern similar to the one shown in the sketch. Wearshield 70 and Lincore 65-O are more abrasion resistant in a single layer.

Asphalt Paving Machine Paddles

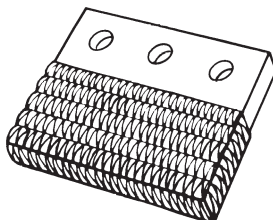

Process	for Build-Up	for Hardfacing
Manual	—	Wearshield 60 Wearshield 70
Semi-automatic	—	Lincore 60-G Lincore 60-O Lincore 65-O

Comments: Apply Wearshield 60 severe abrasion resistant deposits to the top and face as shown in the sketch. Wearshield 70 and Lincore are more abrasion resistant in a single layer.

Sheepsfoot Tampers

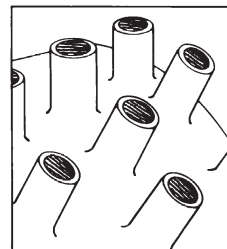

Process	for Build-Up	for Hardfacing
Manual	—	Wearshield 60 Wearshield ME
Semi-automatic	—	Lincore 50 Lincore 60-G Lincore 60-O Lincore 65-O

Comments: Drive short lengths of old pipe onto the worn stubs. Fill the hole in the pipe with hardfacing material. Lincore 50 works well in this application using a puddling technique.

New tampers can be hardfaced before going into service. Use Wearshield 60 to resist severe abrasion.

Other Construction Applications

Parts	Manual Welding Materials Hardfacing	Parts	Manual Welding Materials Hardfacing
Asphalt Mixer Paddle Shanks	Wearshield 60*	Compactors	Wearshield 60*
		Curbing Machine Augers	Wearshield 60*
Paving Screw Conveyors	Wearshield 60*	Backhoe Cutters	Wearshield 60*
Paving Agitator Blades	Wearshield 60*	Trencher Teeth	Wearshield 60*
Grader End Bits	Wearshield 60*	Shredding	Wearshield 60*
Grapple Tines	Wearshield 60*		

* Wearshield 70 can be used in place of Wearshield 60 for greater abrasion resistance in a single layer.

IMPORTANT: SPECIAL VENTILATION AND/OR EXHAUST REQUIRED

Fumes from the normal use of certain hardfacing welding products contain significant quantities of components such as chromium and manganese which can lower the 5.0 mg/m³ maximum exposure guideline for general welding fume.

BEFORE USE, READ AND UNDERSTAND THE MATERIAL SAFETY DATA SHEET (MSDS) FOR THIS PRODUCT AND SPECIFIC INFORMATION PRINTED ON THE PRODUCT CONTAINER.

Never overheat manganese steel. Keep interpass temperatures below 500°F (260°C).

Industry Components

Digging and processing materials in the mining industry provides challenging applications for hardfacing products. Rock, shale, sand, etc. are worked using large equipment such as draglines. Parts must be surfaced to resist wear from mild abrasion with impact to severe abrasion.

Dragline buckets are repaired with Wearshield ABR, Wearshield M-1, Wearshield 44, Wearshield ME, Wearshield 60 and Wearshield 70 stick electrodes or Lincore 50, Lincore 60-O and Lincore 60-G or Lincore 65-O semiautomatic open arc wires. Wearshield 70 provides the best abrasion resistance in a single layer.



Skip Hoists

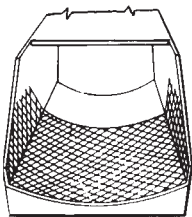

Process	for Build-Up	for Hardfacing
Manual	—	Wearshield 44 Wearshield 60 Wearshield ABR Wearshield ME
Semi-automatic	—	Lincore 50 Lincore 60-G Lincore 60-O Lincore 65-O

Comments: For resistance to moderate impact and moderate abrasion hardface with Wearshield ABR manual electrode or Lincore 50 semiautomatic electrode. In severe abrasion applications, manual electrode Wearshield 60 or Lincore 60-O wire can be used.

Classifier Flights

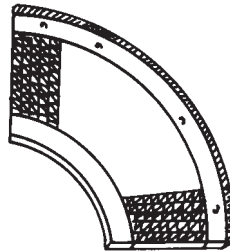

Process	for Build-Up	for Hardfacing
Manual	—	Wearshield 44 Wearshield 60 Wearshield ABR Wearshield ME
Semi-automatic	—	Lincore 50 Lincore 60-G Lincore 60-O Lincore 65-O

Comments: A few stringer beads in the wear areas effectively extend part life in this severe abrasion application. Wearshield ABR or Lincore 50 provide better impact resistance. Wearshield 60 or Lincore 60-O provide better resistance to severe abrasion.

Shaker Pan Conveyors

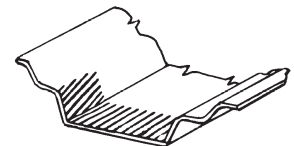

Process	for Build-Up	for Hardfacing
Manual	—	Wearshield 44 Wearshield 60 Wearshield ABR Wearshield ME
Semi-automatic	—	Lincore 50 Lincore 60-G Lincore 60-O Lincore 65-O

Comments: Stringer beads of hardfacing applied where shown in the sketch extend pan life. Wearshield ABR or Lincore 50 provide better impact resistance. Wearshield 60 or Lincore 60-O provide better resistance to severe abrasion.

Ore Chute Baffle Plates

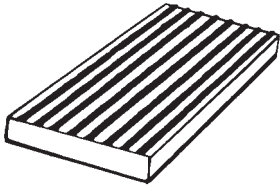

Process	for Build-Up	for Hardfacing
Manual	—	Wearshield 44 Wearshield 60 Wearshield ABR Wearshield ME
Semi-automatic	—	Lincore 50 Lincore 60-G Lincore 60-O Lincore 65-O
Comments: To resist wear in severe abrasion conditions run stringer beads with Wearshield 60 or Lincore 60-O. Where impact is greater use Wearshield ABR, Wearshield 44 or Lincore 50.		

Ball Mill Scoop Lips

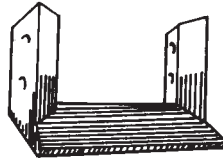

Process	for Build-Up	for Hardfacing
Manual	—	Wearshield 44 Wearshield 60 Wearshield ABR Wearshield ME
Semi-automatic	—	Lincore 50 Lincore 60-G Lincore 60-O Lincore 65-O
Comments: Overlay the working edges with Wearshield 60 or Lincore 60-O for best life in severely abrasive applications. Use Wearshield ABR or Lincore 50 when wear is less severe.		

Ball Mill Scoops

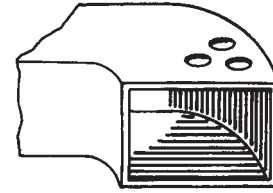

Process	for Build-Up	for Hardfacing
Manual	—	Wearshield 44 Wearshield 60 Wearshield ABR Wearshield ME
Semi-automatic	—	Lincore 50 Lincore 60-G Lincore 60-O Lincore 65-O
Comments: Apply weld deposits as shown in the sketch.		

Slag Ladles

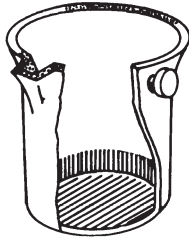

Process	for Build-Up	for Hardfacing
Manual	—	Wearshield 60
Semi-automatic	—	Lincore 50 Lincore 60-O
Comments: Be sure the areas to be welded are cleaned of all remaining slag and dirt. The manual electrode, Wearshield 60, and semiautomatic electrodes, Lincore 50 and Lincore 60-O are recommended for this application.		

Ladle Pins

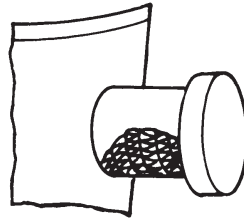

Process	for Build-Up	for Hardfacing
Manual	—	Wearshield M-1 Wearshield MM
Semi-automatic	—	Lincore 55 Lincore 55-G
Comments: Hardface the ladle pins using Wearshield M-1 or Wearshield MM manual electrodes or Lincore 55 or Lincore 55-G semiautomatic welding electrode to resist the metal-to-metal wear. Use proper preheat and inter-pass temperatures.		

Bail Eyes



Process	for Build-Up	for Hardfacing
Manual	—	Wearshield M-1 Wearshield MM
Semi-automatic	—	Lincore 55 Lincore 55-G
Comments: Rebuild the ladle bail eyes using Wearshield MM manual or Lincore 55 semi-automatic welding electrodes to resist metal-to-metal wear. Use proper preheat and interpass temperatures.		

Conveyor Pipe Bends

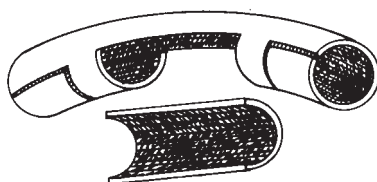

Process	for Build-Up	for Hardfacing
Manual	—	Wearshield 60 Wearshield 70
Semi-automatic	—	Lincore 50 Lincore 60-G Lincore 60-O Lincore 65-O
Comments: Hardface the inside of the pipe bends. Hardface the cover plugs and weld them into position, using a joining electrode.		

Rebuilding Mine Car and Railroad Crew Car Wheels

Although these wheels can be built up by using manual and semiautomatic welding methods, the Automatic Submerged Arc process is by far the most effective and lowest cost way to do the job. Following are suggested materials for welding wheels of these types:

Type of Wheel	Build-up Material	Hardfacing Material
R.R. Crew Car Wheel	Lincore 30-S Wire ⁽¹⁾ 801 Neutral Flux	Lincore 30-S Wire ⁽¹⁾ 801 Neutral Flux
Mine Car Wheels	Lincore 30-S Wire ⁽¹⁾ 801 Neutral Flux Lincore 35-S/801	Lincore 30-S/801 Lincore 35-S/801 Lincore 40-S Wire/ 801 Neutral Flux Lincore 42-S Wire/ 801 Neutral Flux
⁽¹⁾ Recommended as good build-up and surfacing material for good traction on drive wheels.		

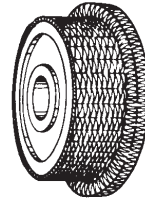

Mine Car wheels

Comments: Most economically rebuilt by automatic submerged arc welding. Use proper preheat, interpass temperature and proper cooling.

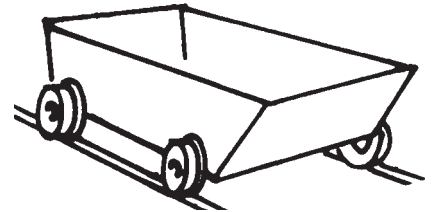

PREHEAT AND INTERPASS TEMPERATURE REQUIREMENTS:

Some wheels are .40 – .50% carbon and are relatively easy to weld. Others are alloy steel and require special treatment before welding. Determine the analysis prior to welding and the amount of preheat required by using a Preheat Calculator (from Lincoln Electric). Cast iron wheels should not be surfaced with the automatic process.

WORK PREPARATION:

Clean wheels of all rust, dirt, grease, etc. before starting to weld. This helps eliminate porosity and unsound welds. Any cracks in wheels should be gouged or ground out and welded prior to automatic welding using low hydrogen manual electrode (Excalibur) after wheel has been properly preheated.

POST WELDING:

Cool wheels slowly after welding by covering with fiberglass blanket or burying in warm flux. Avoid drafts when welding. DO NOT place wheels in vertical position on floor after welding, spot hardening or warping could result.

Suggested welding sequences:

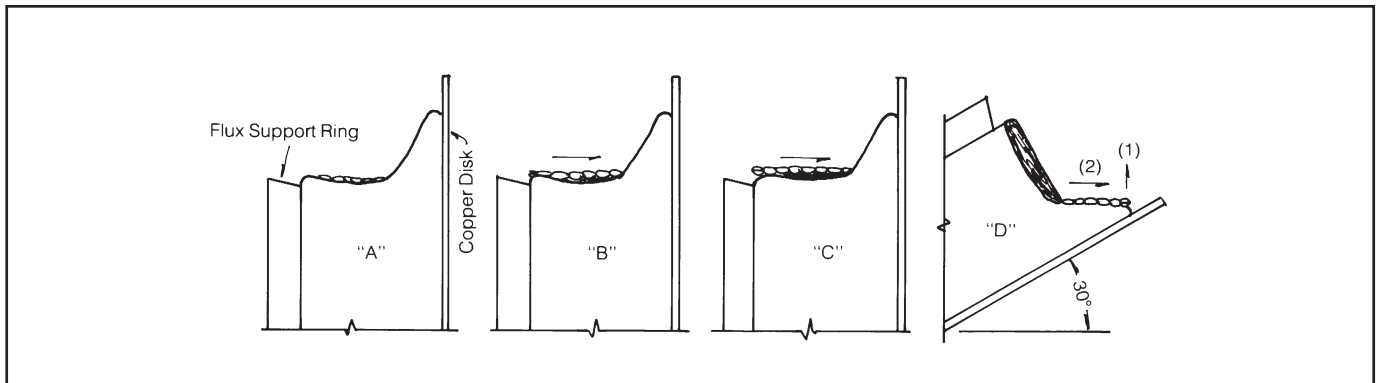

Sequence for depositing beads. "A" — build-up worn areas on tread; "B" — build-up tread to within 3/8" of gauge size; "C" — hardface tread; "D" — hardface flange.

Slusher Teeth

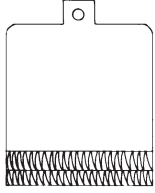

Process	for Build-Up	for Hardfacing
Manual	Wearshield 15CrMn Wearshield Frogmang Wearshield Mangjet	Wearshield 60 Wearshield 70 Wearshield ME
Semi-automatic	Lincore 15CrMn Lincore Frogmang Lincore M	Lincore 50 Lincore 60-G Lincore 60-O Lincore 65-O
Comments: Rebuild the worn teeth to size using Wearshield Mangjet or Lincore M. Add two layers of Wearshield 60 or Lincore 50 as indicated by prior wear patterns to resist abrasive wear. Badly worn teeth should be rebuilt by welding a replacement plate of the proper shape to the tooth using Wearshield 15CrMn manual electrode, or Lincore 15CrMn semiautomatic electrode then hardfacing.		

Slusher Shoes

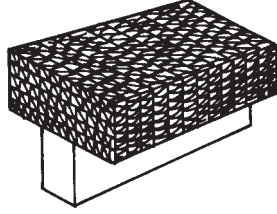

Process	for Build-Up	for Hardfacing
Manual	Wearshield 15CrMn Wearshield Frogmang Wearshield Mangjet	Wearshield 60 Wearshield 70 Wearshield ME
Semi-automatic	Lincore 15CrMn Lincore Frogmang Lincore M	Lincore 50 Lincore 60-G Lincore 60-O Lincore 65-O
Comments: Rebuild these manganese steel parts using Wearshield 15CrMn, Wearshield Mangjet or Lincore M. Two final layers of Wearshield 60, Lincore 50 or Lincore 60-O provide resistance to severe abrasive wear.		

Wheel Excavator Teeth

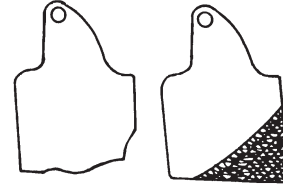

Process	for Build-Up	for Hardfacing
Manual	Wearshield 15CrMn Wearshield Frogmang Wearshield Mangjet	Wearshield 60 Wearshield 70 Wearshield ME
Semi-automatic	Lincore 15CrMn Lincore Frogmang Lincore M	Lincore 50 Lincore 60-G Lincore 60-O Lincore 65-O
Comments: Rebuild the worn teeth to size using Wearshield 15CrMn, Wearshield Mangjet, Lincore 15CrMn or Lincore M. Add two layers of Wearshield 60, Lincore 60-O or Lincore 50 as indicated by prior wear patterns to resist abrasive wear. Badly worn teeth should be rebuilt by welding a replacement plate of the proper shape to the tooth using Wearshield 15CrMn or Lincore 15CrMn electrodes, then hardfacing.		

Pug Mill Paddles

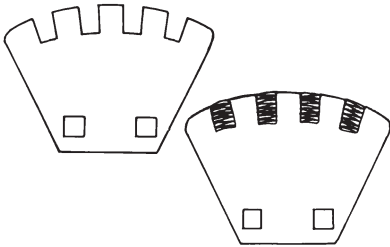

Process	for Build-Up	for Hardfacing
Manual	—	Wearshield 60
Semi-automatic	—	Lincore 60-G Lincore 60-O
Comments: Abrasion resistant Wear-shield 60 weld metal deposited in slots in new paddle castings increases wear life by several times.		

Loader Clutch Lugs

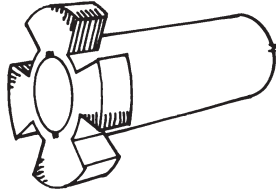

Process	for Build-Up	for Hardfacing
Manual	—	Wearshield MM
Semi-automatic	—	Lincore 33 Lincore 55 Lincore 55-G Lincore BU-G
Comments: Rebuild to size with Wearshield MM manual electrode for excellent resistance to metal-to-metal wear. Proper preheat and slow cooling is needed to avoid cracking.		

IMPORTANT: SPECIAL VENTILATION AND/OR EXHAUST REQUIRED

Fumes from the normal use of certain hardfacing welding products contain significant quantities of components such as chromium and manganese which can lower the 5.0 mg/m³ maximum exposure guideline for general welding fume.

BEFORE USE, READ AND UNDERSTAND THE MATERIAL SAFETY DATA SHEET (MSDS) FOR THIS PRODUCT AND SPECIFIC INFORMATION PRINTED ON THE PRODUCT CONTAINER.

Sprocket Drums and Travelling Sprockets

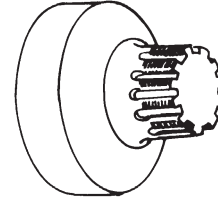

Process	for Build-Up	for Hardfacing
Manual	Wearshield BU Wearshield BU30	Wearshield 44 Wearshield MM
Semi-automatic	—	Lincore 33 Lincore 55 Lincore 55-G Lincore BU-G
Comments: Rebuild the worn areas to size using Wearshield BU or Wearshield MM build-up electrode. Finish by machining or grinding as required.		

Never overheat manganese steel. Keep interpass temperatures below 500°F (260°C).

Other Mining Industry Components

Part	Manual Welding Materials	Semiautomatic Welding Materials
	Hardfacing	Hardfacing
Mechanical Loader Lips	Wearshield 60, Wearshield 70	Lincore 50, Lincore 60-G, Lincore 60-O, Lincore 65-O
Shaker Conveyor Rails	Wearshield 60, Wearshield 70, Wearshield ME	Lincore 50, Lincore 60-G, Lincore 60-O, Lincore 65-O
Grizzlies	Wearshield 60, Wearshield ME	Lincore 50, Lincore 60-G, Lincore 60-O, Lincore 65-O
Ore Chute Arc Doors	Wearshield 44, Wearshield 60, Wearshield ABR	Lincore 50, Lincore 60-G, Lincore 60-O, Lincore 65-O
Wheel Excavator Buckets	Wearshield 60 or Wearshield ME	Lincore 50, Lincore 60-G, Lincore 60-O, Lincore 65-O
Continuous Miner Bearing Carrier	Wearshield M-1, Wearshield MM, Wearshield MM40	Lincore 33, Lincore 55
Loader Dragline Plates	Wearshield 60, Wearshield 70, Wearshield ME	Lincore 50, Lincore 60-G, Lincore 60-O, Lincore 65-O
Loader Undercarriage Runners	Wearshield 60, Wearshield 70, Wearshield ME	Lincore 50, Lincore 60-G, Lincore 60-O, Lincore 65-O
Loader Track Pads	Wearshield 60, Wearshield 70, Wearshield ME	Lincore 50, Lincore 60-G, Lincore 60-O, Lincore 65-O
Cutter Chain Lugs and Straps	Wearshield 60, Wearshield 70, Wearshield ME	Lincore 60-G, Lincore 60-O, Lincore 65-O
Duck Bills	Wearshield 60, Wearshield 70, Wearshield ME	Lincore 50, Lincore 60-G, Lincore 60-O, Lincore 65-O
Digging Arms	Wearshield 60, Wearshield 70, Wearshield ME	Lincore 50, Lincore 60-G, Lincore 60-O, Lincore 65-O



IMPORTANT: SPECIAL VENTILATION AND/OR EXHAUST REQUIRED

Fumes from the normal use of certain hardfacing welding products contain significant quantities of components such as chromium and manganese which can lower the 5.0 mg/m³ maximum exposure guideline for general welding fume.

BEFORE USE, READ AND UNDERSTAND THE MATERIAL SAFETY DATA SHEET (MSDS) FOR THIS PRODUCT AND SPECIFIC INFORMATION PRINTED ON THE PRODUCT CONTAINER.

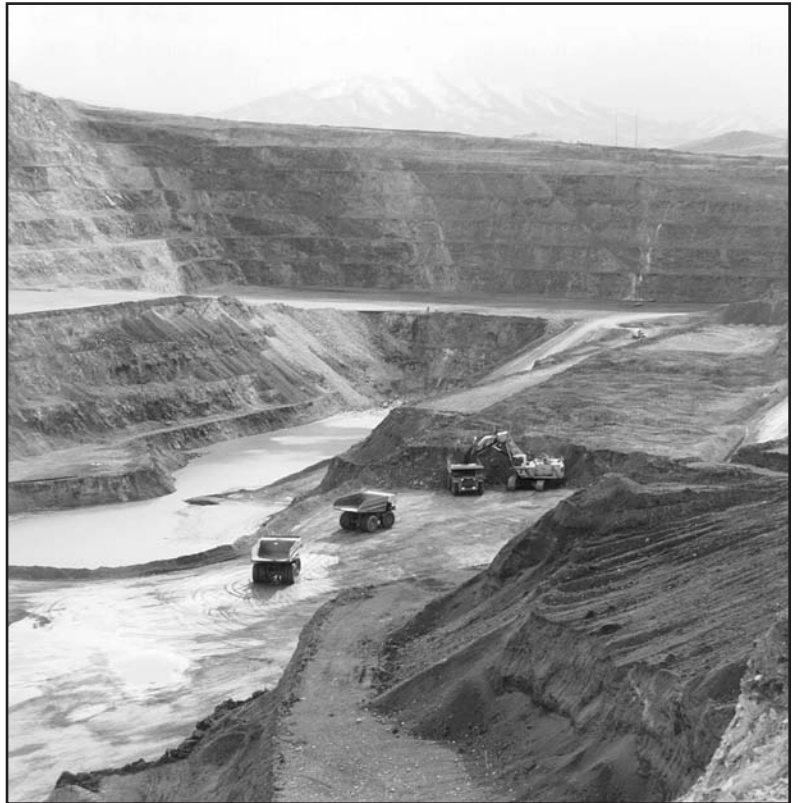

Crushing and Grinding

SECTION 5

Crusher Components

Heavy equipment is used in the crushing and grinding of rock and various earth products. The material processed varies from aggregate to a fine powder. Many key components of this equipment are manufactured from manganese steel. Wherever possible, repair these hammers, rolls and bars with manganese filler metals. The manganese deposits work harden in service to resist gouging or impact wear. It is good practice to finish these applications with a layer of severe abrasion resistant material. This procedure is used typically to repair mantles of bell-type gyratory crushers.

Regardless of the base material (manganese or carbon steel), use the manganese type product for build-up. **Never overheat manganese steel. Keep interpass temperatures below 500°F (260°C).**

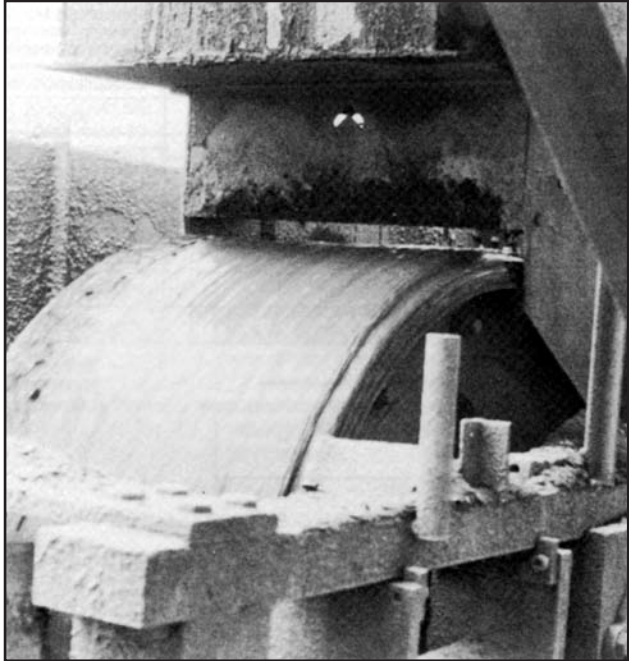

IMPORTANT: SPECIAL VENTILATION AND/OR EXHAUST REQUIRED

Fumes from the normal use of certain hardfacing welding products contain significant quantities of components such as chromium and manganese which can lower the 5.0 mg/m³ maximum exposure guideline for general welding fume.

BEFORE USE, READ AND UNDERSTAND THE MATERIAL SAFETY DATA SHEET (MSDS) FOR THIS PRODUCT AND SPECIFIC INFORMATION PRINTED ON THE PRODUCT CONTAINER.

Rotors and Impeller Bars

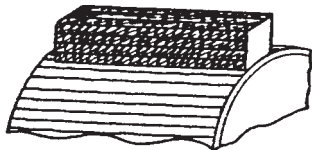

Vertical Deflector Screen Gates and Stripper Bars

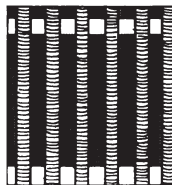

Grizzly Bars

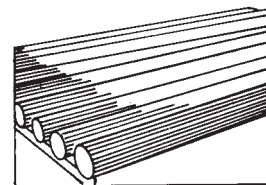

Process	for Build-Up	for Hardfacing
Manual	Wearshield 15CrMn Wearshield Frogmang Wearshield Mangjet	Wearshield 44 Wearshield 60 Wearshield 70 Wearshield ABR Wearshield ME
Semi-automatic	Lincore 15CrMn Lincore Frogmang Lincore M	Lincore 50 Lincore 60-G Lincore 60-O Lincore 65-O
Automatic	Lincore 15CrMn/801 Lincore M Lincore M-1 Lincore M-1/801	Lincore 50/801 Lincore 60-O/803 Lincore 60-S/803 Lincore 65-O
Comments: Rebuild badly worn areas with Lincore 15CrMn or Lincore M for the needed impact resistant base. When abrasive wear is less severe hardface with Lincore 50. Manual welding with Wearshield 15CrMn, Wearshield Mangjet, Wearshield 60 or Wearshield ABR can be used.		

Process	for Build-Up	for Hardfacing
Manual	Wearshield 15CrMn Wearshield 22Mn5Cr Wearshield Mangjet	Wearshield 44 Wearshield 60 Wearshield 70 Wearshield ABR Wearshield ME
Semi-automatic	Lincore 15CrMn Lincore Frogmang Lincore M Lincore M-1	Lincore 50 Lincore 60-G Lincore 60-O Lincore 65-O
Comments: For lowest cost rebuild with Lincore 15CrMn or Lincore M and hardface with Lincore 60-O or Lincore 50 semiautomatic self-shielded welding electrodes. Manual hardfacing using Wearshield 60 or Wearshield ME electrodes can be used.		

Process	for Build-Up	for Hardfacing
Manual	Wearshield 15CrMn Wearshield Frogmang Wearshield Mangjet	Wearshield 44 Wearshield 60 Wearshield 70 Wearshield ABR Wearshield ME
Semi-automatic	Lincore 15CrMn Lincore Frogmang Lincore M	Lincore 50 Lincore 60-G Lincore 60-O Lincore 65-O
Comments: For lowest cost rebuild with Lincore 15CrMn or Lincore M and hard-face with Lincore 50 semiautomatic self-shielded welding electrodes. Manual hardfacing using Wearshield 60 or Wearshield ME electrodes can be used.		

**Never overheat manganese steel.
Keep interpass temperatures below 500°F (260°C).**

Gyratory Crusher Mantles and Liners

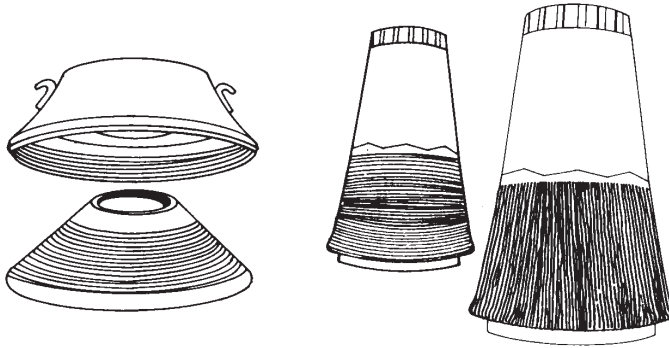

Hardfacing new parts before service increases service life.

Process	for Build-Up	for Hardfacing
Manual	Wearshield 15CrMn Wearshield Frogmang Wearshield Mangjet	Wearshield 60 Wearshield 70
Semi-automatic	Lincore 15CrMn Lincore M	Lincore 50 Lincore 60-O
Automatic	Lincore 15CrMn Lincore MI	Lincore 50/801 Lincore 60-S/803

Comments: These large parts are usually rebuilt only by experienced rebuilders. Rebuild using Lincore 15CrMn or Lincore M with automatic or semiautomatic procedures. When possible or desired, add a maximum of two layers of abrasion-resistant metal using Lincore 60-S/803 flux, Lincore 60-O, Lincore 50 or Lincore 50/801. Contact Lincoln for procedures.

Grinding Rings and Rolls

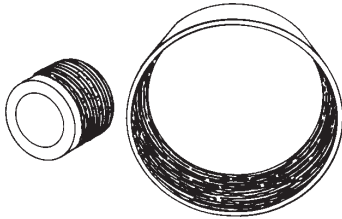

Process	for Build-Up	for Hardfacing
Automatic	—	Lincore 60-O Lincore 60-S/803 Lincore 65-O

Comments: Automatic arc welding using Lincore 60-S/803 flux or Lincore 60-O wire is recommended for long part life in this severe abrasion application. Contact Lincoln for procedures.

Cage Crushers

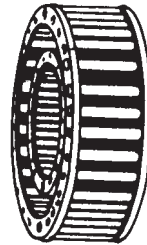

Process	for Build-Up	for Hardfacing
Manual	—	Wearshield 60
Semi-automatic	—	Lincore 60-G Lincore 60-O

Comments: The pins and cage walls of cage-type disintegrating mills can be hardfaced using the manual electrode, Wearshield 60, to resist severe abrasion. Rebuild after limited wear so only one layer is needed.

Crusher Hammer and Carbon Steel Hammer

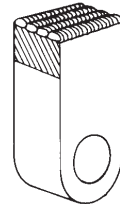

Crusher Hammers		
Process	for Build-Up	for Hardfacing
Manual	Wearshield 15CrMn Wearshield Frogmang Wearshield Mangjet	Wearshield 60 Wearshield ME
Semi-automatic	Lincore 15CrMn Lincore Frogmang Lincore M	Lincore 50 Lincore 60-O

Comments: Rebuild close to final size with manganese steel deposits from Lincore 15CrMn or Lincore M. Finish with two layers of Wearshield 60 or Lincore 60-O to resist severe abrasive wear.

Carbon Steel Hammers

Process	for Build-Up	for Hardfacing
Manual	Wearshield BU30	Wearshield 44 Wearshield ME
Semi-automatic	Lincore 33 Lincore 40-O Lincore 55 Lincore 55-G	Lincore 50 Lincore 55 Lincore 55-G Lincore 60-G Lincore 60-O

Clinker Grinding Rolls

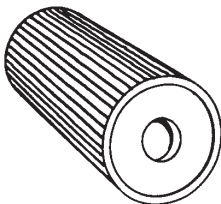

Process	for Build-Up	for Hardfacing
Manual	—	Wearshield 60 Wearshield 70
Semi-automatic	—	Lincore 60-O

Comments: Stringer beads of Wearshield 60 applied across the face of the roll provides gripping action for the rolls and resists severe abrasion.

Scrubbers



Process	for Build-Up	for Hardfacing
Manual	Wearshield 15CrMn Wearshield Frogmang Wearshield Mangjet	Wearshield 60 Wearshield ME
Semi-automatic	Lincore 15CrMn Lincore Frogmang Lincore M	Lincore 50 Lincore 60-G Lincore 60-O

Comments: Stringer beads of Wearshield 60 manual electrode or Lincore 50 or Lincore 60-O semiautomatic wires are placed on the wear plates, and other wear locations to resist the severe abrasive wear.

Scalping and Sizing Vibratory Screens

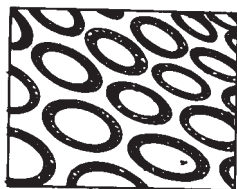

Rotary Screens

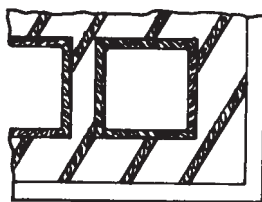

Elevator Bucket Lips

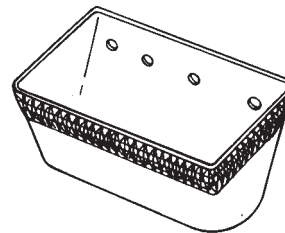

Process	for Build-Up	for Hardfacing
Manual	Wearshield 15CrMn Wearshield Mangjet	Wearshield 60 Wearshield 70
Semi-automatic	Lincore 15CrMn Lincore M	Lincore 60-G Lincore 60-O Lincore 65-O
Comments: Restrain the screen to prevent distortion. Use Lincore M to bring worn areas to size and finish by hardfacing with Wearshield 60 or Lincore 60-O to resist severe abrasion.		

Process	for Build-Up	for Hardfacing
Manual	Wearshield 15CrMn Wearshield Mangjet	Wearshield 60 Wearshield ME
Semi-automatic	Lincore 15CrMn Lincore M	Lincore 50 Lincore 60-G Lincore 60-O
Comments: Repair the worn areas around the holes with Lincore 15CrMn or Lincore M. Finish by depositing abrasion resistant Wearshield 60, Wearshield ME, Lincore 50 or Lincore 60-O.		

Process	for Build-Up	for Hardfacing
Manual	—	Wearshield 60 Wearshield ME
Semi-automatic	—	Lincore 50 Lincore 60-G Lincore 60-O
Comments: Severely worn buckets are best repaired by cutting new lips from steel plate and welding them on with Blue Max 309L or Blue Max 2100. Hardface to resist severe abrasion.		

IMPORTANT: SPECIAL VENTILATION AND/OR EXHAUST REQUIRED

Fumes from the normal use of certain hardfacing welding products contain significant quantities of components such as chromium and manganese which can lower the 5.0 mg/m³ maximum exposure guideline for general welding fume.

BEFORE USE, READ AND UNDERSTAND THE MATERIAL SAFETY DATA SHEET (MSDS) FOR THIS PRODUCT AND SPECIFIC INFORMATION PRINTED ON THE PRODUCT CONTAINER.

Other Crushing, Grinding and Screening Applications

Parts	Manual Welding Recommended Material		Semiautomatic Welding Recommended Material	
	Build-up	Hardfacing	Build-Up	Hardfacing
Gyratory Crusher Cross Heads	—	Wearshield 44 Wearshield ABR	—	Lincore 50
Wobbler Feeder	—	Wearshield 15CrMn Wearshield Mangjet	—	Lincore 15CrMn Lincore M
Crusher Points	Wearshield Mangjet	Wearshield 60 Wearshield ME	Lincore M Lincore 15CrMn	Lincore 50 Lincore 60-G Lincore 60-O
Log Washer Paddles	Wearshield Mangjet	Wearshield 60 Wearshield ME	Lincore M Lincore 15CrMn	Lincore 50 Lincore 60-G Lincore 60-O
Gravel Washer Auger Flights	—	Wearshield 60 Wearshield 70 Wearshield ME	—	Lincore 50 Lincore 60-G Lincore 60-O Lincore 65-O
Quarry Drill Flutes	—	Wearshield 60 Wearshield ME	—	Lincore 50 Lincore 60-G Lincore 60-O
Quarry Drill Auger Periphery and Leading Flights	—	Wearshield 60 Wearshield 70 Wearshield ME	—	Lincore 50 Lincore 60-G Lincore 60-O Lincore 65-O

**SPECIAL
FEATURE:**

Hardfacing Cut-Out Chart for Quick Reference.



	The "Wear"	"Wear" to Use		What to "Wear"		
				Stick Electrode (Rc)	Flux-Cored Wires (Rc) Self-Gas-Shielded	Sub-Arc Tubular Wires & Neutral Flux (Rc)
BUILD-UP		Restore to original size weld without cracking substrate for harder alloy (Ferrite/Bainite)	Any hardfacing application with excessive wear, to restore to original shape before hardfacing	Wearshield BU (23-28) Wearshield BU-30 (28-32)	Lincore BU (Rb80-90) Lincore 33 (32-36) Lincore BU-G (21-33)	Lincore 20/801 (23-28) Lincore 30-S/801 (29-32) Lincore 32-S/801 (31-34) Lincore 35-S/801 (35-40) Lincore 4130/801 (17-21) Lincore 8620/801 (16-20)
		(Austenite)	Spalling resistant substrate for chromium carbides	Wearshield 15CrMn (17-20)	Lincore 15CrMn (18-22)	Lincore 15CrMn/801 18-22)
METAL-TO-METAL		Metal-to-Metal wear (Martensite)	Crane wheels, cable sheaves, sprockets, gear teeth	Wearshield MM (52-58)	Lincore 40-O (40-45) Lincore 55 (50-59) Lincore 55-G (50-59)	Lincore 40-S/801 (39-42) Lincore 42-S (39-42)
		Metal-to-Metal wear and heat (tool steel martensite)	Punch & forging dies, shear blades, work rolls	Wearshield T&D (58-65)	Lincore T&D (48-65)	Lincore 102HC/802 (50-56) Lincore 102W/802 (48-54)
		Metal-to-Metal wear and impact (martensite and austenite)	Earth moving and agricultural equipment	Wearshield M-1 (50-58)	Lincore 40-O (40-46) Lincore 55 (50-59) Lincore 55-G (50-59)	Lincore 102HC/802 (50-56)
		Metal-to-Metal wear with thermal fatigue and corrosion (high chromium martensite)	Steel mill caster rolls	Wearshield 420 (52-57)	See Sub-Arc	Lincore 96S/801 (48-54) Lincore 410/801 (27-32) Lincore 410NiMo/801 (32-40) Lincore 420/801 (46-50) Lincore 423Cr/802 (41-47) Lincore 423L/802 (41-47) Lincore 424A/801 (36-42)
		Work hardening buildup for severe impact (austenite manganese)	Crusher hammers, construction equipment	Wearshield 15CrMn (17-20) Wearshield Mangjet (17-20)	Lincore 15CrMnLS (18-22) Lincore M-1 (18-28)	Lincore 15CrMnLS/801 (18-22) Lincore M-1/801 18-28)
	Railroad frogs and crossing diamonds		Wearshield Frogmang (20-23) 22Mn 5Cr	Lincore Frogmang (20-55) Lincore Frogmang-G (20-55)	—	
ABRASION		Abrasion plus impact (austenite and carbides)	Teeth, blades, bucket & dump body surfaces	Wearshield 44 (40-46) Wearshield ABR (28-53)	Lincore 50 (48-52)	Lincore 50/803 (48-65)
METAL-TO-EARTH		Metal-to-Metal wear abrasion plus impact (austenite and eutectic)	Bucket teeth, scraper blades, paddles, hammers, crusher rolls	Wearshield ME (49-59)	Lincore 50 (48-52)	Lincore 50/803 (48-65)
SEVERE ABRASION		Severe abrasion (primary carbides)	Crusher rolls, conveyer screws, plates, jaws	Wearshield 60 (57-60) Wearshield 70 (68-70) Wearshield SM880	Lincore 60-G (58-61) Lincore 60-O (55-60) Lincore 65-O (60-65)	Lincore 60-O/803 (55-62) Lincore 60-S/803 (55-60) Lincore 65-O/803 (60-65)
		Severe abrasion (cast chrome carbide)	Tillage tools, earth engaging tools, sweeps, knives	—	—	—

Cement Mill Components

Many of the components used to manufacture cement, bricks and clay products are similar to those covered in the “Crushing and Grinding” and the “Mining” sections. However, applications unique to cement mills include augers, blades, and knife edges. Such parts often can be repaired with a manual severe abrasion resistant electrode that can also resist compression. Lincoln’s Wearshield 60 is such a product.

A deposit made with a severe abrasion resistant electrode cannot be heat treated or machined. It must be ground, if finishing is required.

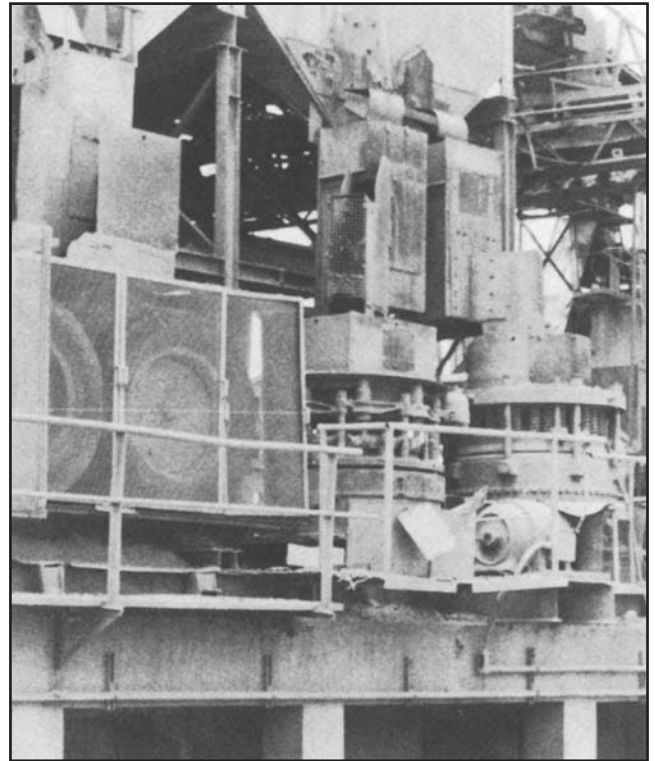

Kiln Trunnions

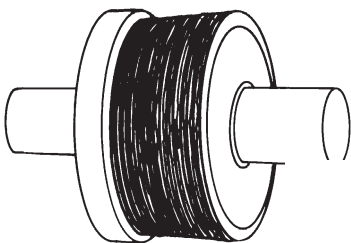

Process	for Build-Up	for Hardfacing
Automatic	Lincore 20/801 Lincore 30-S/801 Lincore 4130/801	L-60/A-96S (limit 4 layers) Lincore 30-S/801 Lincore 420/801
Comments: Automatic submerged arc welding is recommended for speed and economy. Rebuild with an unlimited number of layers using the flux-cored electrode Lincore 30-S with 801 flux. Add two layers of hardfacing using A-96S/ L-60 or Lincore 420/801.		

Screw Flight Shaft Bearings, Hangers & Gudgeon Pins

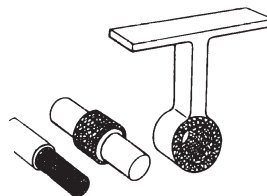

Process	for Build-Up	for Hardfacing
Manual	—	Wearshield 60 Wearshield 70
Semi-automatic	—	Lincore 60-O Lincore 65-O
Comments: Deposit Wearshield 60 hardfacing to the wear areas as shown in the sketch.		

Bag Packer Screws

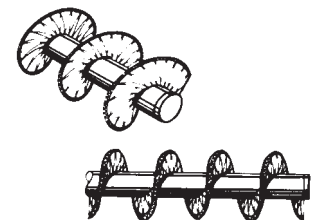

Process	for Build-Up	for Hardfacing
Manual	—	Wearshield 60 Wearshield 70
Semi-automatic	—	Lincore 60-O Lincore 65-O
Comments: To resist severe abrasion deposit one or two layers of Wearshield 60 to the worn areas of the flight faces and edges as shown in the sketch.		

Pulverizer Mill Components

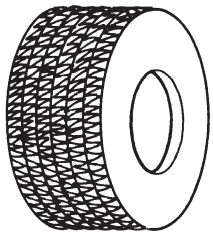
Roll Heads 	Process	for Build-Up	for Hardfacing
	Manual	—	Wearshield 60 Wearshield 70
	Semi-automatic	—	Lincore 60-O Lincore 65-O
	Automatic	—	H-560/L-60 Lincore 60-S/803 Lincore 65-O
Comments: Apply Wearshield 60 or Lincore 60-O for excellent abrasion resistance. Automatic submerged arc welding with Lincore 60-S/803 flux or H-560 flux and L-60 electrode can also be used.			

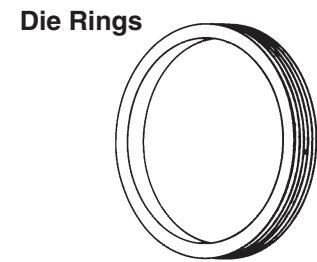

Process	for Build-Up	for Hardfacing
Manual	—	Wearshield 60 Wearshield 70
Semi-automatic	—	Lincore 60-G Lincore 60-O Lincore 65-O
Automatic	—	Lincore 60-S/803 Lincore 65-O
Comments: Wearshield 60 manual electrode is recommended for the extremely high abrasion resistance needed.		

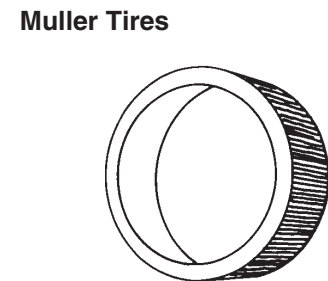

Process	for Build-Up	for Hardfacing
Manual	—	Wearshield 44 Wearshield 60 Wearshield ABR Wearshield ME
Semi-automatic	—	Lincore 50 Lincore 60-G Lincore 60-O Lincore 65-O
Comments: Hardfacing new Muller tires and rewelding areas worn in service using transverse beads with Wearshield ABR electrodes provides a long working life. Lincore 50 semiautomatic wire can also be used.		

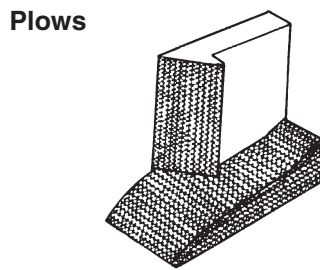

Process	for Build-Up	for Hardfacing
Manual	—	Wearshield 60 Wearshield 70
Semi-automatic	—	Lincore 60-G Lincore 60-O Lincore 65-O
Comments: Wearshield 60 manual electrode is recommended for the extremely high abrasion resistance needed.		

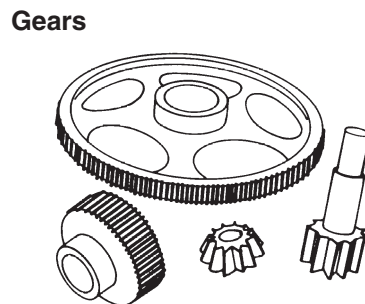

Process	for Build-Up	for Hardfacing
Manual	—	Wearshield BU Wearshield BU30 Wearshield MM
Semi-automatic	—	Lincore 33 Lincore 40-O Lincore 55 Lincore 55-G Lincore T&D
Comments: Many of the various types of gears used throughout the industry can be rebuilt using Wearshield MM manual electrode or Lincore 33, Lincore 55 or Lincore T&D semiautomatic wire. Finish by grinding as required.		

Slurry Tank Agitator Bearings

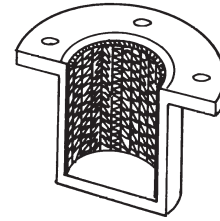

Process	for Build-Up	for Hardfacing
Manual	—	Wearshield 60 Wearshield 70
Semi-automatic	—	Lincore 60-G Lincore 60-O
Comments: Hardface the bearing area using Wearshield 60. Finish by grinding as required.		

Slurry Tank Agitator Shafts

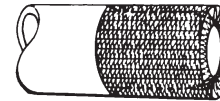

Process	for Build-Up	for Hardfacing
Manual	—	Wearshield 60 Wearshield 70
Semi-automatic	—	Lincore 60-G Lincore 60-O Lincore 65-O
Comments: Hardface the bearing area using Wearshield 60. Finish by grinding as required.		

Concrete Truck

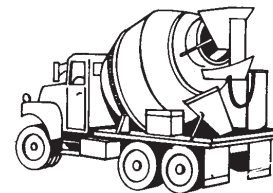

Process	for Build-Up	for Hardfacing
Manual	—	Wearshield 44 Wearshield 60 Wearshield 70 Wearshield ABR Wearshield M-1 Wearshield ME
Semi-automatic	—	Lincore 50 Lincore 60-O Lincore 65-O
Comments: All types of cement mixers can be hardfaced by covering the entire inside, including blending wings, using Lincore 50 and Lincore 60-O electrode and semiautomatic welding. Manual welding with Wearshield ABR, Wearshield M1 or Wearshield 60 is also practical. Be certain sufficient ventilation is provided to workers when inside the mixer.		

Brick and Clay Manufacturing Components

Pug Mill Augers

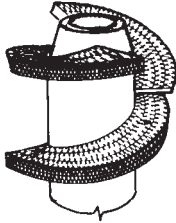

Process	for Build-Up	for Hardfacing
Manual	—	Wearshield 60 Wearshield 70 Wearshield ME
Semi-automatic	—	Lincore 50 Lincore 60-G Lincore 60-O Lincore 65-O
Comments: Wearshield 60 manual electrode provides an extremely hard surface to resist the severe abrasive wear of this application. For semiautomatic welding use Lincore 60-O or Lincore 50.		

Spreader Cones

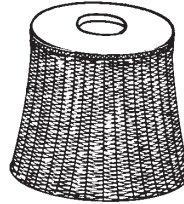

Process	for Build-Up	for Hardfacing
Manual	—	Wearshield 60 Wearshield 70 Wearshield ME
Semi-automatic	—	Lincore 50 Lincore 60-G Lincore 60-O Lincore 65-O
Comments: Wearshield 60 manual electrode provides an extremely hard surface to resist the severe abrasive wear of this application. For semiautomatic welding use Lincore 60-O or Lincore 50.		

Feeder Blades

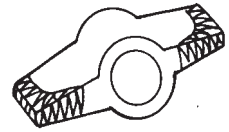

Process	for Build-Up	for Hardfacing
Manual	—	Wearshield 60 Wearshield 70 Wearshield ME
Semi-automatic	—	Lincore 50 Lincore 60-G Lincore 60-O Lincore 65-O
Comments: Wearshield 60 manual electrode provides an extremely hard surface to resist the severe abrasive wear of this application. For semiautomatic welding use Lincore 60-O or Lincore 50.		

Conveyor and Vertical Mixer Screws

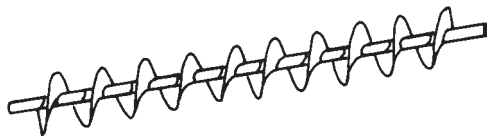

Process	for Build-Up	for Hardfacing
Manual	—	Wearshield 44 Wearshield 60 Wearshield 70 Wearshield ABR Wearshield ME
Semi-automatic	—	Lincore 50 Lincore 60-G Lincore 60-O Lincore 65-O
Comments: Hardface the screw flights to resist severe abrasion using Wearshield 60 or Lincore 60-O. When moderate impact accompanies the abrasive wear use Wearshield ME, Wearshield ABR, Lincore 50.		

Other Industry Components

Part	Manual Welding Material		Semiautomatic Welding Material	
	Build-Up	Hardfacing	Build-Up	Hardfacing
Kiln Feed Screw Bearing	—	Wearshield 60 Wearshield 70 Wearshield ME	—	Lincore 50 Lincore 60-G Lincore 60-O Lincore 65-O
Feed Inlet Tubes	—	Wearshield 60 Wearshield 70 Wearshield ME	—	Lincore 50 Lincore 60-G Lincore 60-O Lincore 65-O
Fan Blades	—	Wearshield 60 Wearshield 70 Wearshield ME	—	Lincore 50 Lincore 60-G Lincore 60-O Lincore 65-O
Induced Draft Fans	—	Wearshield 60 Wearshield 70 Wearshield ME	—	Lincore 50 Lincore 60-G Lincore 60-O Lincore 65-O
Drag Chain Links	Wearshield BU Wearshield BU30	Wearshield 60 Wearshield 70 Wearshield ME	Lincore 33 Lincore BU-G	Lincore 50 Lincore 60-G Lincore 60-O Lincore 65-O
Drag Chain Drive Sprockets	Wearshield BU Wearshield BU30	Wearshield M-1 Wearshield MM	Lincore 33 Lincore BU-G	Lincore 55 Lincore 40-O
Pug Mill Knives	—	Wearshield 60 Wearshield 70 Wearshield ME	—	Lincore 50 Lincore 60-G Lincore 60-O Lincore 65-O
Shredder Knives	—	Wearshield 60 Wearshield 70 Wearshield ME	—	Lincore 50 Lincore 60-G Lincore 60-O Lincore 65-O
Barrel Liners	—	Wearshield 60 Wearshield 70 Wearshield ME	—	Lincore 50 Lincore 60-G Lincore 60-O Lincore 65-O

Dredge Pump Parts

The repair of dredge pumps is a good example of using hardfacing to increase the life of equipment. The casing and the impeller blades wear from the abrasion and impact of sand and rock. These parts can be returned to better than new condition by selecting and applying the proper build-up and hardfacing material.

Dredge pump casings are made from cast iron, manganese steel, and carbon steel. Rebuilding cast iron pumps is not recommended. Manganese and carbon steel pumps can be rebuilt. Observe the precautions needed to avoid distortion and cracking of the base metal.

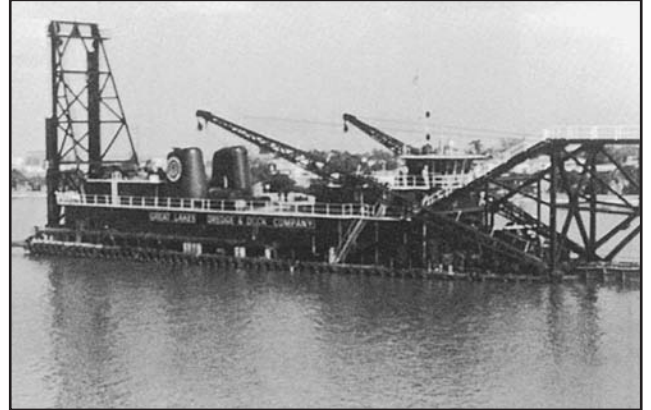

Pump Casings

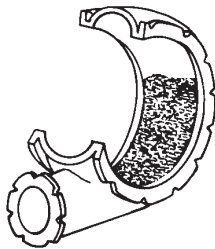

Base Metal: Carbon Steel		
Process	for Build-Up	for Hardfacing
Manual	Wearshield BU Wearshield BU30	Wearshield 44 Wearshield 60 Wearshield 70 Wearshield ABR Wearshield ME
		Lincore 50 Lincore 60-G Lincore 60-O Lincore 65-O
Semi-automatic/ Automatic	Lincore 33 Lincore BU-G	Lincore 50 Lincore 60-G Lincore 60-O Lincore 65-O
Base Metal: Manganese Steel		
Process	for Build-Up	for Hardfacing
Manual	Wearshield 15CrMn Wearshield Mangjet	Wearshield 44 Wearshield 60 Wearshield 70 Wearshield ABR Wearshield ME
		Lincore 50 Lincore 60-G Lincore 60-O Lincore 65-O
Semi-automatic/ Automatic	Lincore 15CrMn Lincore M	Lincore 50 Lincore 60-G Lincore 60-O Lincore 65-O
Comments: The entire internal diameter of new castings should be hardfaced before they are placed in service. When necessary, rebuild worn areas with the recommended buildup materials. Hardface using Wearshield 70, Wearshield 60, Lincore 60-O or Lincore 65-O to resist severe abrasion. For moderate abrasion accompanied by moderate impact hardface with Wearshield ABR, Wearshield 44 or Lincore 50.		

Pump Impellers

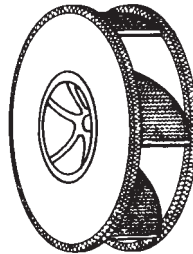

Base Metal: Carbon Steel		
Process	for Build-Up	for Hardfacing
Manual	Wearshield BU Wearshield BU30	Wearshield 44 Wearshield 60 Wearshield 70 Wearshield ABR Wearshield ME
		Lincore 50 Lincore 60-G Lincore 60-O Lincore 65-O
Semi-automatic	Lincore 33 Lincore BU-G	Lincore 50 Lincore 60-G Lincore 60-O Lincore 65-O
Base Metal: Manganese Steel		
Process	for Build-Up	for Hardfacing
Manual	Wearshield 15CrMn Wearshield Mangjet	Wearshield 44 Wearshield 60 Wearshield 70 Wearshield ABR Wearshield ME
		Lincore 50 Lincore 60-G Lincore 60-O Lincore 65-O
Semi-automatic	Lincore 15CrMn Lincore M	Lincore 50 Lincore 60-G Lincore 60-O Lincore 65-O
Comments: Rebuild severely worn manganese steel vanes using Wearshield Mangjet or Lincore M; carbon steel vanes using Wearshield BU, Wearshield BU30 or Lincore 33. Hardface with Wearshield 60, Wearshield 70 Lincore 60, Lincore 65-O to resist severe abrasion. Use Wearshield ABR, Wearshield 44 or Lincore 50 when moderate impact accompanies abrasive wear.		

Side Plates

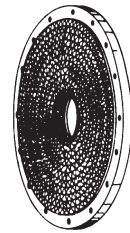

Base Metal: Carbon Steel		
Process	for Build-Up	for Hardfacing
Manual	Wearshield BU Wearshield BU30	Wearshield 60 Wearshield 70 Wearshield ME
		Lincore 50 Lincore 60-G Lincore 60-O Lincore 65-O
Semi-automatic	Lincore 33 Lincore BU-G	Lincore 50 Lincore 60-G Lincore 60-O Lincore 65-O
Base Metal: Manganese Steel		
Process	for Build-Up	for Hardfacing
Manual	Wearshield 15CrMn Wearshield Mangjet	Wearshield 60 Wearshield 70 Wearshield ME
		Lincore 50 Lincore 60-G Lincore 60-O Lincore 65-O
Semi-automatic	Lincore 15CrMn Lincore M	Lincore 50 Lincore 60-G Lincore 60-O Lincore 65-O
Comments: Rebuild worn seat areas using Wearshield BU, Lincore 33 or Lincore BU for carbon steel plates and Wearshield Mangjet or Lincore M for manganese steel plates. Hardface the side plates with Wearshield 60, Wearshield 70, Wearshield ME, Lincore 60-O or Lincore 50.		

Pipeline Ball Joints

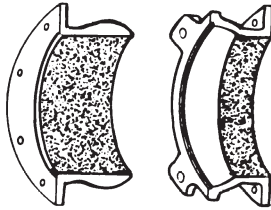

Process	for Build-Up	for Hardfacing
Manual	—	Wearshield 60 Wearshield 70 Wearshield ME
Semi-automatic	—	Lincore 50 Lincore 60-G Lincore 60-O Lincore 65-O

Comments: Hardface the wear areas as indicated in the sketch using Wearshield 60, manual electrodes. Use Lincore 50 or Lincore 60-O semiautomatic welding for higher deposit rates.

Dredge Cutters and Teeth

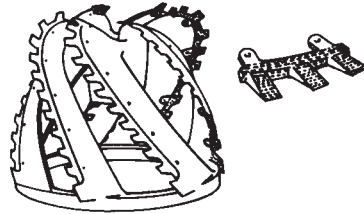

Base Metal: Carbon Steel		
Process	for Build-Up	for Hardfacing
Manual	Wearshield BU Wearshield BU30	Wearshield 60 Wearshield 70 Wearshield ME
Semi-automatic	Lincore 33 Lincore BU-G	Lincore 50 Lincore 60-G Lincore 60-O Lincore 65-O

Base Metal: Manganese Steel		
Process	for Build-Up	for Hardfacing
Manual	Wearshield 15CrMn Wearshield Mangjet	Wearshield 60 Wearshield 70 Wearshield ME
Semi-automatic	Lincore 15CrMn Lincore M	Lincore 50 Lincore 60-G Lincore 60-O Lincore 65-O

Comments: Depending on base metal, rebuild worn blades with the recommended build-up material and hardface with Wearshield 60, Wearshield ME, Lincore 60-O or Lincore 50. Hardface new and worn replaceable teeth using these same electrodes.

Dredge Bucket Lips

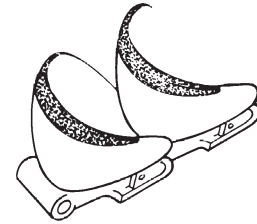

Process	for Build-Up	for Hardfacing
Manual	—	Wearshield 44 Wearshield 60 Wearshield 70 Wearshield ABR Wearshield ME
Semi-automatic	—	Lincore 50 Lincore 60-G Lincore 60-O Lincore 65-O

Comments: Hardface new and worn lips with Wearshield 60 or Lincore 60-O to resist severe abrasion. Use Wearshield ABR, Wearshield ME or Lincore 50 when abrasive wear is accompanied by moderate impact. If badly worn, consider replacing the lips with manganese or carbon steel plate depending upon the bucket base metal.

Lower Tumblers

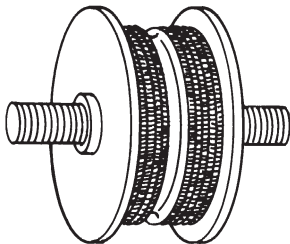

Base Metal: Carbon Steel		
Process	for Build-Up	for Hardfacing
Manual	Wearshield BU Wearshield BU30	Wearshield MM
Semi-automatic	Lincore 33 Lincore BU-G	Lincore 55 Lincore 55-G

Base Metal: Manganese Steel		
Process	for Build-Up	for Hardfacing
Manual	Wearshield 15CrMn Wearshield Frogmang Wearshield Mangjet	Wearshield 15CrMn Wearshield Frogmang Wearshield Mangjet
Semi-automatic	Lincore 15CrMn Lincore Frogmang Lincore M	Lincore 15CrMn Lincore Frogmang Lincore M

Comments: Rebuild close to size by depositing circumferential beads using the appropriate build-up materials for carbon or manganese steel base metal. Finish manganese steel tumblers with Wearshield Mangjet, Wearshield 15CrMn manual electrodes or Lincore M, Lincore 15CrMn semiautomatic electrodes. Finish carbon steel tumblers with Wearshield MM or Lincore 55.

Ladder Rolls

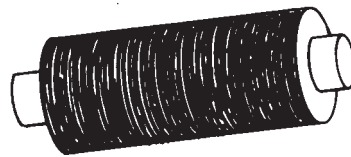

Process	for Build-Up	for Hardfacing
Manual	Wearshield BU Wearshield BU30	Wearshield MM
Automatic	Lincore 20/801 Lincore 30-S/801 Lincore 4130/801 Lincore 8620/801 Lincore BU-G	Lincore 30-S/801 Lincore 420/801 Lincore 4130/801

Comments: For greatest economy rebuild these rolls on submerged arc automatic welding equipment use Lincore 420/801 flux or Lincore 4130/801 flux. Wearshield BU manual electrode can also be used to rebuild rolls to size then overlay with circumferential beads using Wearshield MM.

Ladder Roll Bearing Box

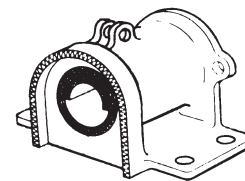

Process	for Build-Up	for Hardfacing
Manual	Wearshield BU Wearshield BU30	—
Semi-automatic	Lincore 33 Lincore BU-G	—

Comments: Rebuild the worn surfaces with machinable build-up deposits using Wearshield BU or Lincore 33.

Other Dredging Parts

Parts	Recommended Manual Welding Materials		Recommended Semiautomatic Welding Materials	
	Build-Up	Hardfacing	Build-Up	Hardfacing
Pipeline Swivels, Elbows and Wyes	—	Wearshield ABR Wearshield MI	—	Lincore 50
Pan Head Lips	—	Wearshield 60 Wearshield 70	—	Lincore 60-G Lincore 60-O Lincore 65-O
Spud Clamps	Wearshield 15CrMn Wearshield Mangjet	Wearshield 60 Wearshield 70	Lincore 15CrMn Lincore M	Lincore 60-G Lincore 60-O Lincore 65-O
Spud Points	Wearshield 15CrMn Wearshield Mangjet	Wearshield 60 Wearshield 70	Lincore 15CrMn Lincore M	Lincore 60-G Lincore 60-O Lincore 65-O
Bucket Pins	Wearshield BU	Wearshield MM	Lincore 33 Lincore BU-G	Lincore 55
Bucket Eyes and Bottoms Manganese Steel	Wearshield 15CrMn Wearshield Frogmang Wearshield Mangjet	Wearshield 15CrMn Wearshield Frogmang Wearshield Mangjet	Lincore 15CrMn Lincore Frogmang Lincore M	Lincore 15CrMn Lincore M
Drive Tumblers	Wearshield BU Wearshield BU30	Wearshield BU Wearshield BU30	Wearshield BU Wearshield BU30 Lincore BU-G	Lincore 33 Lincore 40-O
Drive Tumbler Plates Manganese Steel Carbon Steel	—	Wearshield 60 Wearshield 70 Wearshield ME	—	Lincore 50 Lincore 60-G Lincore 60-O Lincore 65-O
Retard Rings	—	Wearshield 44 Wearshield 70 Wearshield 60 Wearshield ABR Wearshield ME	—	Lincore 50 Lincore 60-G Lincore 60-O Lincore 65-O

IMPORTANT: SPECIAL VENTILATION AND/OR EXHAUST REQUIRED

Fumes from the normal use of certain hardfacing welding products contain significant quantities of components such as chromium and manganese which can lower the 5.0 mg/m³ maximum exposure guideline for general welding fume.

BEFORE USE, READ AND UNDERSTAND THE MATERIAL SAFETY DATA SHEET (MSDS) FOR THIS PRODUCT AND SPECIFIC INFORMATION PRINTED ON THE PRODUCT CONTAINER.

Never overheat manganese steel. Keep interpass temperatures below 500°F (260°C).

Industry Components

Steel mill applications involve every type of metal wear. Base metals range through manganese, high carbon, and alloy steel. Therefore, selection of procedures and hardfacing materials for these applications require a thorough understanding of the basic rules of hardfacing.

Steel mill rolls are typical of equipment to be repaired by hardfacing. Wear on rolls may be caused by metal-to-metal friction plus corrosion. In many cases, a modified stainless steel deposit is recommended to prolong roll life. On the other hand, certain coke oven parts may require a deposit that will resist severe abrasion at high temperature.

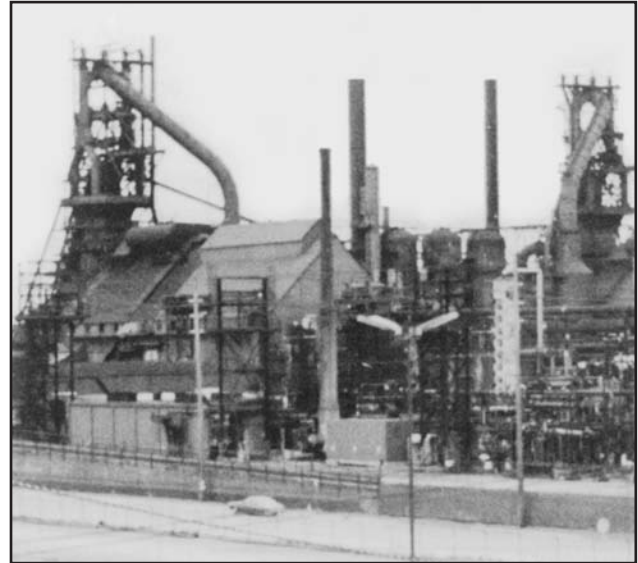

Blast Furnace Tap Hole Drill Bit

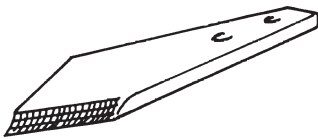

Process	for Build-Up	for Hardfacing
Manual	—	Wearshield 60 Wearshield 70
Semi-automatic	—	Lincore 60-G Lincore 60-O Lincore 65-O

Pig Iron Casting Machine Rails

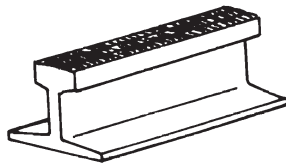

Process	for Build-Up	for Hardfacing
Manual	—	Wearshield M-1 Wearshield MM Wearshield T&D
Comments: Deposit stringer beads as shown in the sketch for an excellent impact and abrasion resistant surface.		

Coke Oven Pusher Shoes

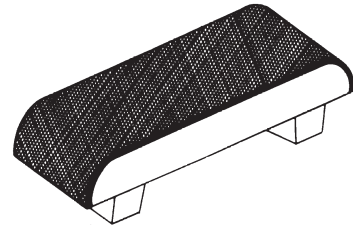

Process	for Build-Up	for Hardfacing
Manual	—	Wearshield 60 Wearshield 70
Semi-automatic	—	Lincore 60-G Lincore 60-O Lincore 65-O

Blast Furnace Bells And Hoppers

Rebuild the seat area using Lincore 102W and 802 Flux, Lincore 420 and 801 flux or A-96S alloy flux and L-60 wire. Rebuild the burden area with Lincore 60-O, Lincore 60-S/803 flux or H-560 alloy flux with L-60 electrode. For details of this critical application, contact The Lincoln Electric Company, Application Engineering Department.

Open Hearth Charging Box

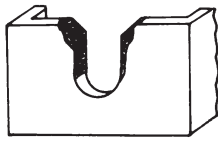

Base Metal: Carbon Steel		
Process	for Build-Up	for Hardfacing
Manual	Wearshield BU Wearshield BU30	Wearshield MM
Semi-automatic	Lincore 33 Lincore BU-G	Lincore 40-O Lincore 55 Lincore 55-G

Base Metal: Manganese Steel		
Process	for Build-Up	for Hardfacing
Manual	Wearshield Mangjet	Wearshield MM
Semi-automatic	Lincore 15CrMn Lincore M	Lincore 40-O Lincore 55 Lincore 55-G

Comments: Use the manual electrode Wearshield BU or the open arc wire Lincore 33 to build-up the worn ends of carbon steel boxes close to size as shown in the sketch. Use Lincore M or Wearshield Mangjet for manganese steel boxes. Hardface with Wearshield MM or Lincore 55 to resist the metal-to-metal service wear.

Open Hearth Peel Heads

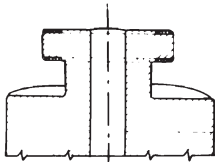

Base Metal: Carbon Steel		
Process	for Build-Up	for Hardfacing
Manual	Wearshield BU Wearshield BU30	Wearshield MM
Semi-automatic	Lincore 33 Lincore BU-G	Lincore 33 Lincore 40-O Lincore 55 Lincore 55-G Lincore BU-G

Base Metal: Manganese Steel		
Process	for Build-Up	for Hardfacing
Manual	Wearshield 15CrMn Wearshield Mangjet	Wearshield MM
Semi-automatic	Lincore 15CrMn Lincore M	Lincore 40-O Lincore 55 Lincore 55-G

Comments: Use the manual electrode Wearshield BU or the open arc wire Lincore 33 to build carbon steel peel heads close to size. Use Lincore M, Lincore 15CrMn or Wearshield Mangjet for manganese steel parts. Hardface with Wearshield MM or Lincore 55 to resist the metal-to-metal service wear.

Ingot Buggy Wheels and Tracks

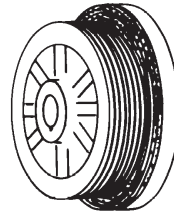

Ingot Buggy Dump Pistons

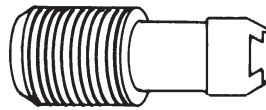

Process	for Build-Up	for Hardfacing
Semi-automatic	Lincore 33 Lincore BU Lincore BU-G	—
Automatic	Lincore 30-S/801	—

Comments: Use automatic submerged arc welding with Lincore 30-S and 801 flux for maximum economy. Semiautomatic welding with Lincore 33 open arc welding is also practical.

Sintering Plant Pallets

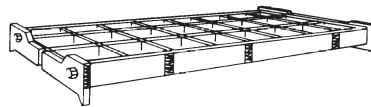

Process	for Build-Up	for Hardfacing
Manual	—	Wearshield MM
Semi-automatic	—	Lincore 55 Lincore 55-G

Comments: Repair the worn areas as indicated in the sketch with Wearshield MM manual electrode.

Sintering Plant Wheels

Comments: Inspect then repair all cracks and surface defects. Build-up for metal-to-metal wear by depositing either transverse or circumferential beads using Lincore 33 or Wearshield BU.

Process	for Build-Up	for Hardfacing
Semi-automatic	Lincore 33	Lincore 33 Lincore 40-O Lincore 55
Automatic	Lincore 30-S/801 Lincore 35-S/801	A-96S/L-60 Lincore 420/801

Comments: Use Lincore 30-S with 801 flux to rebuild wheels to size. Hardface with Lincore 420/801 flux or A-96S alloy flux with L-60 wire. Lincore 33 and Lincore 55 self-shielded flux-cored electrode with semiautomatic methods can also be used. Observe proper preheat and interpass temperature precautions.

Blooming Mill Manipulator Rest Bar

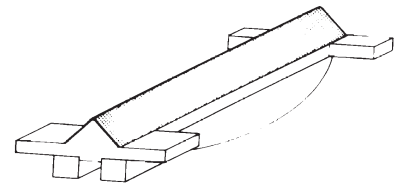

Process	for Build-Up	for Hardfacing
Manual	—	Wearshield MM
Semi-automatic	—	Lincore 55 Lincore 55-G Lincore T&D
Automatic	—	Lincore 102W/802 Lincore 40-S/801

Comments: Hardface with Lincore 40-S with 801 flux or Wearshield MM manual electrode for resistance to metal-to-metal wear.

Sintering Plant Augers

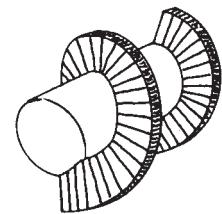

Process	for Build-Up	for Hardfacing
Manual	—	Wearshield 60 Wearshield 70
Semi-automatic	—	Lincore 60-G Lincore 60-O Lincore 65-O

Comments: Use Wearshield 60 for this severe abrasion application. Hardface the flight faces and periphery.

STEEL MILL ROLL REBUILDING

Rebuilding of steel mill rolls of all types by submerged arc welding affords the steel companies tremendous opportunities to make substantial savings in rolling mill costs. Many rolls which would normally be scrapped after only 10 percent or less of the original material in them has been lost due to wear can be reclaimed by replacing worn sections with suitable submerged arc welded deposits. The type of weld deposit required and the procedure necessary to obtain the required wear resistance depend upon a number of factors.

These are:

1. Service to which roll will be subjected:

- A. Rolls on primary mills such as blooming and slabbing mills or continuous casters where rolls are subjected to thermal shock.
- B. Roughing mills where slabs or blooms are reduced to billets, plates, strip, etc.
- C. Finishing mills where further reduction of the final product takes place.
- D. Leveler and straightener rolls where final products such as bars, pipe, sheet, etc., are straightened.
- E. Table Rolls — These are really conveyor rolls over which the material is moved from one section of the mill to another.

2. Analysis of the base metal of the roll being considered for reclamation:

- A. AISI-SAE 1030 and 1040 steel mill rolls and the low carbon alloy steels require a moderate preheat of 250°-400°F (120°-200°C) at the start of welding.
- B. Some steel mill rolls are medium carbon alloy steels and require a thorough preheat. The preheat temperature varies with the base metal but a normal range is 500°F-750°F (260°-400°C).
- C. Other steel mill rolls, for example finishing rolls, are made of high carbon alloy steels with complex metallurgical structures. Restoring dimensions by welding is generally not recommended, because fracture of the roll body is likely.

In any case, it is important to obtain the proper preheat temperature from a Preheat Calculator and to maintain the preheat during welding and follow proper post heat treatments for successful results.

3. Physical condition of roll:

- A. How much weld deposit will be required?
- B. Size, diameter and length of roll?
- C. Cast or forged - are they sound?
- D. Surface condition - cracked? How much work will be required to obtain crack free surface?

The following rolling equipment offer substantial savings when rebuilt by arc welding:

- I. The Roll Body
- II. The Roll Necks (Bearing Seats)
- III. Wobblers
- IV. Coupling Boxes
- V. Main Drive Spindles

Following are some suggestions for rebuilding roll bodies:

Type Roll Body Being Built	Hardfacing Material (Automatic - Submerged Arc)
Continuous Caster Rolls	Lincore 420/801 A-96S Alloy Flux/L-60 Wire
Straightener & Leveler Rolls	Lincore 102W/802 A-96S Alloy Flux/L-60 Wire
Table Rolls	Lincore 30 /801 Lincore 4130/801 or Lincore 102W/802 A-96S Alloy Flux/L-60 Wire
Preheat rolls prior to welding. Preheat temperature will depend upon chemical analysis of roll along with its mass. Refer to "Suggested Preheat and Interpass Temperatures" for welding various types of steel or check with Lincoln Preheat Calculator. Preheat and interpass temperature of the hardenable weld deposits (martensitic) must be kept above the transformation start temperature from the start of welding until all welding is complete.	
Deposits may be machined at slow speeds with carbide or other special tooling, or they may be ground.	

Contact Lincoln Electric's Application Engineering Department for proper welding procedures.

Foundry Parts

Flasks

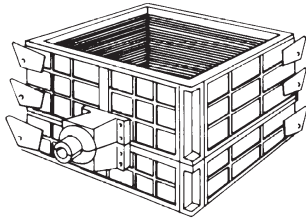

Process	for Build-Up	for Hardfacing
Manual	Wearshield BU Wearshield BU30	—
Semi-automatic	Lincore 33 Lincore 40-O Lincore BU-G	—
Comments: Use Wearshield BU, or Lincore 33 to rebuild carbon steel flasks. Machine to size after welding.		

Muller Tires

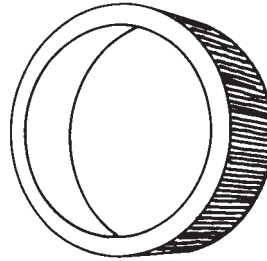

Process	for Build-Up	for Hardfacing
Automatic	—	H-560/L-60 Lincore 60-S/803
Comments: Most foundry Muller tires are cast iron and hardfacing is not recommended. Cast steel tires should be hardfaced when new using submerged arc automatic welding with Lincore 60-S with 803 flux or H-560 flux and L-60 wire.		

Sand Slinger Cups

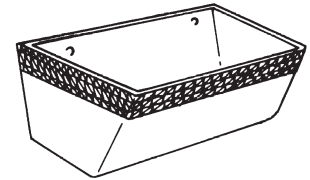

Process	for Build-Up	for Hardfacing
Manual	—	Wearshield 60 Wearshield 70
Semi-automatic	—	Lincore 60-G Lincore 60-O Lincore 65-O
Comments: Deposit stringer beads on the face and leading edge using Wearshield 60 electrode. Semiautomatic welding with Lincore 60-O can also be used.		

Other Iron and Steel Applications

Parts	Recommended Manual Welding Materials		Recommended Semiautomatic Welding Materials	
	Build-Up	Hardfacing	Build-Up	Hardfacing
Sintering Plant Finger Crushers	—	Wearshield 60 Wearshield 70	—	Lincore 60-O & 60-G Lincore 60-O & 60-G Lincore 65-O
Ash Conveyor	—	Wearshield 60 Wearshield 70	—	Lincore 60-O & 60-G Lincore 60-O & 60-G Lincore 65-O
Mill Plows	—	Wearshield 60 Wearshield 70	—	Lincore 60-O & 60-G Lincore 60-O & 60-G Lincore 65-O
Wear Pads for Stock Heating Furnaces	Blue Max 309/309L AC/DC Red Baron 309/309L MR	Wearshield MM Wearshield T & D	—	Lincore 55 Lincore T&D
Cooling Bed Rolls and Dump Shoes	—	Wearshield 60 Wearshield 70	—	Lincore 60-O & 60-G Lincore 60-O & 60-G Lincore 65-O
Charging Furnace Wet Skids	—	Wearshield MM	—	Lincore 55
Cam Dumper Track	Wearshield BU Wearshield BU30	—	Lincore 33 Lincore 40-O Lincore BU-G	—

NOTE: Lincoln Electric manufactures numerous Lincore electrodes that are designed for submerged arc welding with Lincolnweld fluxes, primarily for use on steel mill rolls. Request **Publication C7.10** for specific information on these electrodes.

IMPORTANT: SPECIAL VENTILATION AND/OR EXHAUST REQUIRED

Fumes from the normal use of certain hardfacing welding products contain significant quantities of components such as chromium and manganese which can lower the 5.0 mg/m³ maximum exposure guideline for general welding fume.

BEFORE USE, READ AND UNDERSTAND THE MATERIAL SAFETY DATA SHEET (MSDS) FOR THIS PRODUCT AND SPECIFIC INFORMATION PRINTED ON THE PRODUCT CONTAINER.

Other Industries

SECTION 9

Many hardfacing applications are common to more than one industry. For example, the pounding on a railroad frog is essentially the same as the severe impact wear experienced on some impact hammers. Wheels used in mining, manufacturing and the steel industry are subjected to similar metal-to-metal wear. When hardfacing products have been selected for an application in one industry they can be used for similar parts in other industries. **The important point to remember is that the wear type must be identified.**

Hardfacing should be utilized by small companies as well as large. Many industries, such as fishing, marine and agriculture, not covered in this guide, can also take advantage of the benefits of hardfacing. The recommendations for many of the parts can be applied to similar parts in all kinds of industries.

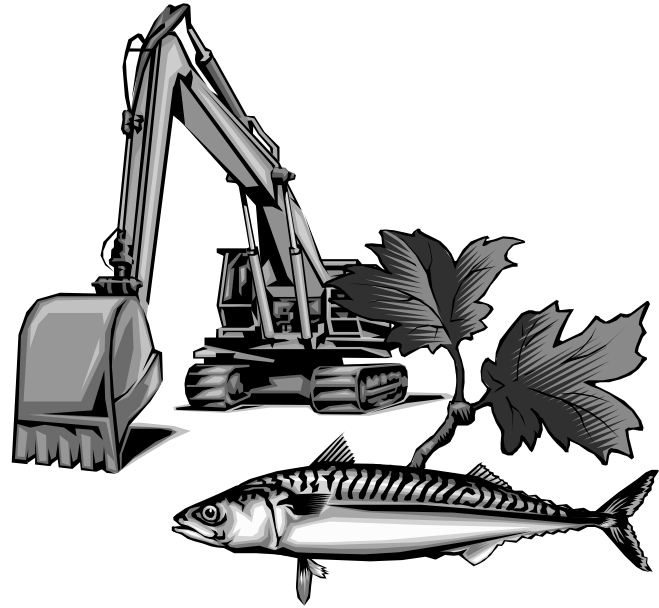

Rubber Industry Mixing Machines

End Plates

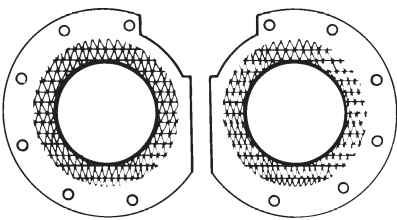

Process	for Build-Up	for Hardfacing
Manual	—	Wearshield 60
		Wearshield ME
		Wearshield ABR
		Wearshield 44
Semi-automatic	—	Lincore 50
		Lincore 60-G
		Lincore 60-O
		Lincore 65-O
Automatic	—	H-560/L-60
		Lincore 60-S/803
		Lincore 65-O

Comments: Cover the areas indicated in the sketch with two layers of hardfacing. Remove from service and reweld as soon as possible after wearing through the hard metal.

Discharge Doors or Gates

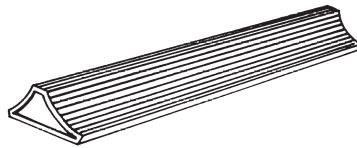

Process	for Build-Up	for Hardfacing
Manual	—	Wearshield 60
		Wearshield 70
Semi-automatic	—	Lincore 60-G
		Lincore 60-O
		Lincore 65-O
Automatic	—	H-560/L-60
		Lincore 60-S/803
		Lincore 65-O

Comments: Hardface worn areas using two layers of hardfacing. Preheat and slow cool as required.

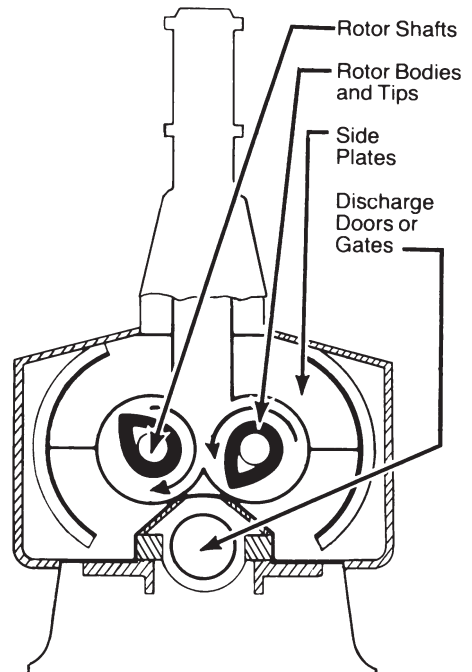

Comments: Rebuild rotor shafts using submerged arc automatic welding with Lincore 30-S and 801 flux. Hardface rotor bodies and tips with Wearshield 60 manual electrode. Hardface mixing chamber using Lincore 60-O flux-cored semiautomatic electrode or Lincore 60-S with 803 flux.

Railroads

Frogs, Switches, Rail Ends, Cross-Overs

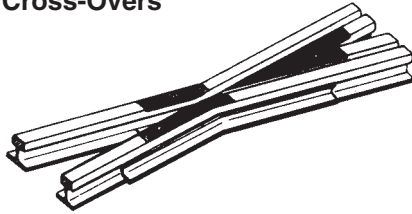

Manganese Steel	Carbon Steel
1. Grind off all work-hardened and fatigued base metal.	1. Grind off work-hardened and fatigued base metal.
2. Overbuild slightly with Wearshield Mangjet, Wearshield Frogmang, Lincore Frogmang or Lincore M. Weave beads approx. 3/4" (19mm) wide. Skip weld to prevent build-up of interpass temp. Do not allow interpass temp to exceed 500°F (260°C). Peen each bead.	2. Preheat to 800°F (425°C).
3. Finish grind.	3. Apply Wearshield BU, BU30, Lincore 33 or Lincore 40-O in weave beads. Overbuild to allow for finish grinding.
	4. Postheat 1100°F (600°C) and cover with a fiberglass blanket.

Logging

Logging Arch Wheels

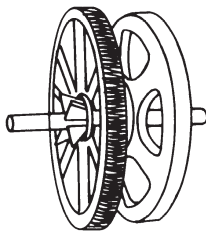

Process	for Build-Up	for Hardfacing
Manual	Wearshield BU Wearshield BU30	Wearshield MM
Semi-automatic	Lincore 33 Lincore BU-G	Lincore 33 Lincore 55 & 55-G Lincore 40-O
Automatic	Lincore 30-S/801 H-535/L-60	Lincore 40-S/801
Comments: Rebuild close to final size and hardface using manual, semiautomatic or automatic welding methods and the materials listed above. As with hardfacing any wheel, use the proper preheat and interpass temperature.		

Bark Conveyor Trunnions

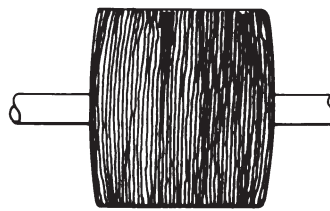

Process	for Build-Up	for Hardfacing
Manual	Wearshield BU Wearshield BU30	Wearshield BU Wearshield BU30 Wearshield MM
Semi-automatic	Lincore 33 Lincore BU-G	Lincore 33 Lincore 40-O Lincore 55 Lincore 55-G Lincore BU-G
Automatic	Lincore 30-S/801	Lincore 40-S/801
Comments: Most economically reconditioned using automatic submerged arc methods. Trunnions can also be welded using semiautomatic and manual welding. Preheat and slow cooling is required.		

Drive Sprockets and Drums

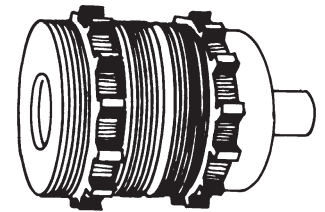

Process	for Build-Up	for Hardfacing
Manual	Wearshield BU Wearshield BU30	Wearshield MM
Semi-automatic	Lincore 33 Lincore BU-G	Lincore 33 Lincore 40 Lincore 55 Lincore 55-G Lincore BU-G
Automatic	Lincore 30-S/801	Lincore 40-S/801
Comments: Provide the metal-to-metal wear resistant surface on worn sprocket teeth using Wearshield MM manual electrode. Rebuild worn drums using automatic submerged arc procedures available from The Lincoln Electric Company.		

Hog Teeth

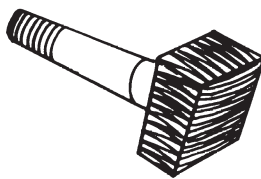

Process	for Build-Up	for Hardfacing
Manual	—	Wearshield 60 Wearshield 70 Wearshield ME
Semi-automatic	—	Lincore 55 Lincore 60-G Lincore 60-O Lincore 65-O
Comments: Provide the needed severe abrasion resistant deposit by hardfacing with Wearshield 60 or Lincore 60-O.		

Hog Rotor

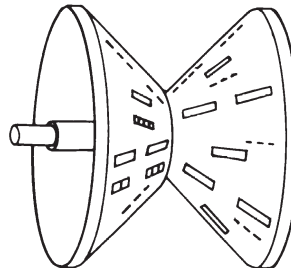

Process	for Build-Up	for Hardfacing
Manual	Wearshield BU Wearshield BU30	Wearshield 44 Wearshield ABR
Semi-automatic	Lincore 33 Lincore BU-G	Lincore 50
Comments: Rebuild the worn area around the knife slots using Wearshield BU. Overlay the entire wear area using Wearshield ABR electrode or Lincore 50. Take all necessary precautions to minimize distortion of the rotors.		

Chain Drive Tumblers

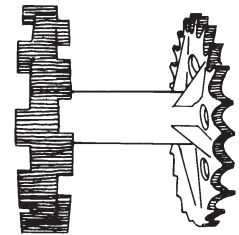

Process	for Build-Up	for Hardfacing
Manual	—	Wearshield MM
Comments: Overlay the tumbler drive blocks with two layers of metal-to-metal wear resistant deposits from Wearshield MM electrode.		

Paper Pulp Digester Cladding

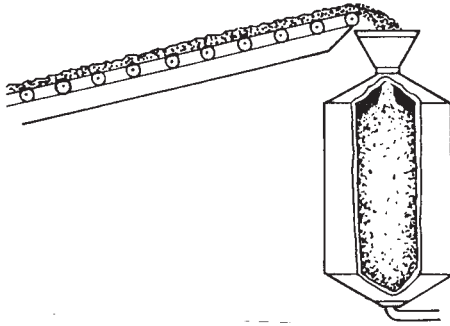

In simplest terms, a digester is a steel vessel in which wood chips are cooked at temperatures upwards of 350°F (180°C) and pressures upwards of 150 psi. The digesters are made of carbon steel and vary in size up to 12 ft. (3.6m) in diameter and 52 ft. (15.8m) long. The wall thickness in some cases may be as much as 2" (50mm). These digesters are mounted vertically, usually, with the building built around the vessel.

At one time, the expected life of digesters was from 10 to 15 years; but modifications of processing designed to increase production have led to increased corrosion resulting in a need for repairs in as short a time as two years.

Stainless overlay surfaces have been the most successful solution to this problem. Various paper mills establish their own specific specifications regarding the exact chemistry they think is best for the cladding material. Also, the Technical Association of the Pulp & Paper Industry, 360 Lexington Ave., N.Y., N.Y. has established specifications and guidelines. Some very high alloy stainless or nickel base overlays are also being applied.

Cladding material has been applied to the inside of the digester wall by manual, semiautomatic and automatic arc welding.

Because of its ability to put down high quality weld deposits at low costs, the submerged arc automatic welding process has emerged as one of the better ways to get the job done.

Equipment to be Cladded	Cladding Materials
Inside walls of Paper Pulp Digester	Blue Max S316/316L elec./ Lincoln ST-100 Flux Blue Max S309/309L elec./ Lincoln ST-100 Flux ER 310 elec./ Blue Max 2000 Flux
The deposits made with the above electrode/flux combinations are of the austenitic chrome-nickel type. Preheating, except to prevent underbead cracking in the base metal, is generally not recommended.	

The following are some of the materials suggested for the cladding process:

For high alloy stainless cladding (e.g. 904L-AWS Class ER385) or nickel base alloy cladding (e.g. Hastelloy C-276-AWS Class ErNiCrMo-4), Blue Max 2000 flux is recommended.

Equipment used for automatic welding consists of:

1. Automatic submerged arc welding head mounted on a fixture that will automatically index the head approximately one half a bead width vertically after a bead has been made completely around the inner diameter of digester. Since the beads are being laid on a vertical surface (the 3 o'clock position) provision must be made to support the flux. This is accomplished by using a belt supported on rollers. The belt of this assembly which is spring loaded rides against the tank being clad and supports the flux properly until the weld bead has been deposited.
2. Welding Power Source — 1000 amp D.C. Rectifier Power Source designed with line voltage compensation.

IMPORTANT: SPECIAL VENTILATION AND/OR EXHAUST REQUIRED

Fumes from the normal use of certain hardfacing welding products contain significant quantities of components such as chromium and manganese which can lower the 5.0 mg/m³ maximum exposure guideline for general welding fume.

BEFORE USE, READ AND UNDERSTAND THE MATERIAL SAFETY DATA SHEET (MSDS) FOR THIS PRODUCT AND SPECIFIC INFORMATION PRINTED ON THE PRODUCT CONTAINER.

Hydrapulper Rotors

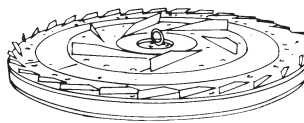

Process	for Build-Up	for Hardfacing
Manual	Blue Max 309L AC/DC or Red Baron 309/309L	Wearshield 60 Wearshield 70
Comments: Rebuild both inner and outer segments using Blue Max 309L AC/DC stainless steel manual electrode. Finish with two layers of Wearshield 60 or one layer of Wearshield 70.		

Pulp Digester Valves

Comments: Rebuild the valves using similar methods and materials used to clad pulp digesters.

REBUILDING TOOL JOINTS FOR ROTARY DRILLING

Although worn, rotary drilling unit tool joints can be rebuilt to size by any of the electric arc welding processes:

1. Manual
2. Semiautomatic
3. Automatic

The most effective and economical process to use is automatic submerged arc. Following are suggestions covering materials to be used along with recommended preheats.

Equipment to be Rebuilt	Build-up Material	Hardfacing Hard Banding
Tool Joint	H-535/L-60 Lincore 15CrMn Lincore 30/801 Lincore 32-S/801	H-560/L-60 Lincore 60-G Lincore 60-O Lincore 60-S/803 Lincore T&D
<p>Rebuild tool joints before they are worn too badly. Use build-up welding materials to bring worn areas back to diameter slightly under desired size. Then hardface to desired diameter with materials indicated above. Many tool joints are rebuilt using only the build up materials with no hardfacing layers.</p>		
<p>Preheat Requirements: Use a preheat of approximately 600°F (315°C) on alloy steel base metal (AISI-SAE 4150 Steels). Lower alloy content material may require lower preheats. Check with the Lincoln Preheat Calculator.</p>		

Rebuilding Other Drilling Equipment

Kellys and Kelly Bushings		
Process	for Build-Up	for Hardfacing
Manual	—	Wearshield BU Wearshield BU30
Semi-automatic	—	Lincore 33 Lincore 40-O Lincore BU-G

Comments: Preheat as required. Rebuild slightly oversize to allow for finish grinding or machining. Use Wearshield BU or Lincore 33. After welding retard cooling by covering with a non-flammable blanket, dry sand, etc.

Water Well Drilling Churn Drills

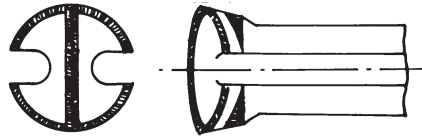

Process	for Build-Up	for Hardfacing
Manual	—	Wearshield 60 Wearshield 70
Semi-automatic	—	Lincore 60-G Lincore 60-O Lincore 65-O

Comments: For drilling in clay, hardface the working surface as shown with abrasion resistant Wearshield 60.

Other Miscellaneous Applications

Parts	Manual Welding Materials		Semiautomatic Welding Materials	
	Build-Up	Hardfacing	Build-Up	Hardfacing
Railroad Tie Saw Blades	Wearshield Mangjet	Wearshield 60 Wearshield 70	Lincore M	Lincore 60-G Lincore 60-O Lincore 65-O
Crib-Cleaning Machining Digging Lugs	—	Wearshield 60 Wearshield 70	—	Lincore 60-G Lincore 60-O Lincore 65-O
Locomotive Gears	—	Wearshield BU Wearshield BU30	—	Lincore 33 Lincore BU-G
Well Drilling Cat Heads	—	Wearshield BU Wearshield BU30	—	Lincore 33 Lincore BU-G
Cable Tool Under-reamer Lugs	—	Wearshield 60 Wearshield 70	—	Lincore 60-G Lincore 60-O Lincore 65-O
Clutch Jaws	Wearshield BU Wearshield BU30	Wearshield MM	Lincore 33 Lincore BU-G	Lincore 55 Lincore 55-G
Log Grapple	—	Wearshield 60 Wearshield 70	—	Lincore 60-G Lincore 60-O Lincore 65-O
Saw Carriage Wheels	—	Wearshield BU Wearshield BU30	—	Lincore 33 Lincore BU-G
Debarking Hammers	Tips	Wearshield 60 Wearshield 70	—	Lincore 60-G Lincore 60-O Lincore 65-O
	Heads	—	Wearshield MM	Lincore 55 Lincore 55-G
Debarker Chain Links	—	Wearshield MM	—	—
Debarker Rotor Knives	—	Wearshield T&D	—	Lincore T&D
Log Escalator Geared Idler	—	Wearshield MM	—	Lincore 55 Lincore 55-G
Conveyor Chains and Links	Metal-to-Metal	—	Wearshield MM	Lincore 55 Lincore 55-G
	Abrasion Wear	—	Wearshield 60 Wearshield 70	Lincore 60-G Lincore 60-O Lincore 65-O
Log Haul Chairs	—	Wearshield 60 Wearshield 70	—	Lincore 60-G Lincore 60-O Lincore 65-O
Grit Collector Idlers	—	Wearshield BU Wearshield BU30	—	Lincore 33 Lincore BU-G
Cutter Blocks	Blue Max 309L AC/DC Red Baron 309/309LMR	Wearshield T&D	Blue Max MIG 309LSi	Lincore T&D

IMPORTANT: SPECIAL VENTILATION AND/OR EXHAUST REQUIRED

Fumes from the normal use of certain hardfacing welding products contain significant quantities of components such as chromium and manganese which can lower the 5.0 mg/m³ maximum exposure guideline for general welding fume.

BEFORE USE, READ AND UNDERSTAND THE MATERIAL SAFETY DATA SHEET (MSDS) FOR THIS PRODUCT AND SPECIFIC INFORMATION PRINTED ON THE PRODUCT CONTAINER.

THE PROCESS SELECTION

MANUAL ELECTRODE WELDING

Recommended:

For irregular shapes, out-of-position welding, low volume applications, and many small parts.

Advantages:

1. Highly versatile because it handles:
 - a. Nearly any shape or contour.
 - b. All positions. However, positioning for downhand welding is recommended.
 - c. Small or large parts.
 - d. Any deposit pattern.
2. Inexpensive equipment. Requires only minimum fixturing and any conventional welder: motor-generator, engine driven, or rectifier. DC is recommended, but AC can be used with many electrodes.

Limitations:

1. Labor costs are relatively high because deposition rates are lower than mechanized processes.
2. Human error can result in poor weld quality or a rough surface.

AUTOMATIC WELDING

Recommended:

For large or repeated applications when labor savings offset equipment costs.

Advantages:

1. Low weld costs due to high deposition rates and fast welding speeds production.
2. Consistent weld quality and a smooth surface are assured by mechanical guidance and automatic controls.
3. Semiautomatic welding with Lincore self-shielded electrodes (no granular flux or shielding gas) approaches the versatility of stick electrode welding.
4. Almost any conventional semiautomatic or automatic welder can be used.

Limitations:

1. Welding equipment costs can be substantial. Fixturing is also often required.
2. Submerged arc welding is limited to the flat position or roundabouts. Its ability to weld contours and odd shapes is limited.

GENERAL GUIDELINES

IMPORTANT: SPECIAL VENTILATION AND/OR EXHAUST REQUIRED

Fumes from the normal use of certain hardfacing welding products contain significant quantities of components such as chromium and manganese which can lower the 5.0 mg/m³ maximum exposure guideline for general welding fume.

BEFORE USE, READ AND UNDERSTAND THE MATERIAL SAFETY DATA SHEET (MSDS) FOR THIS PRODUCT AND SPECIFIC INFORMATION PRINTED ON THE PRODUCT CONTAINER.

Remember, when considering steps to avoid spalling and cracking problems, you are usually depositing the buildup layer on the base metal and the hardfacing on the buildup metal. Wearshield Mangjet®, Wearshield 15CrMn, Lincore® M and Lincore 15CrMn deposits are manganese steel. Wearshield BU, Wearshield BU30 Lincore 30, Lincore 33 and H-535/L-60 deposits are low carbon, low alloy steel. If underbead cracking becomes a problem when rebuilding high carbon or other crack-sensitive steel, an initial buttering layer with Excalibur 7018, NS-3M or mild steel flux and wire may be needed.

The Buildup Materials

Some hardfacing deposits have a limited practical deposit thickness. Therefore, rebuild badly worn parts to within 3/16-3/8" (4.8mm-9.5mm) of original size before hardfacing. Choice of the buildup material depends primarily on the base metal of the part as follows:

- a. Buildup Manganese Steel Parts with Wearshield Mangjet, Wearshield 22Mn5Cr or Wearshield 15CrMn stick electrodes or Lincore M or Lincore 15CrMn Lincore 22Mn5Cr flux-cored wire.
- b. Buildup Carbon and Low Alloy Steels with either Wearshield BU or Wearshield BU30 stick electrode, H-535 submerged arc flux and L-60, Lincore 30-S/801 or Lincore 33.

Preparing the Surface

Remove grease and oil with a solvent and rust and dirt by wire brushing. If not removed, these contaminant's can cause porosity, cracking and poor deposit quality.

To provide a good bond between base metal and weld, remove cracks, remains of old high alloy hardfacing deposits and badly work hardened or distorted surfaces by arc gouging or grinding. Fill cracks, gouges and surface depressions by manual welding. Use Wearshield

BU or Wearshield BU30 on carbon and low alloy steels or Wearshield Mangjet on manganese steel.

Preheat and Interpass Temperature

Most applications require preheating, as a minimum to bring the part to room temperature of 70-100°F. Medium to high carbon and low alloy steels may require higher preheat to prevent underbead cracking, weld cracking, spalling, or stress failure of the part.

Higher preheat and interpass temperature are also needed for massive or rigid parts and when cracking actually occurs. Determine the preheat needed for each job from the information shown elsewhere in this manual.

NEVER OVERHEAT MANGANESE STEEL. KEEP INTERPASS TEMPERATURES BELOW 500°F (260°C).

Surfacing cast iron parts requires special procedures. Request Lincoln **Publication C8.10**, for details.

How to Apply Preheat

Preheating is done with gas or oil torches, ovens, or electrical heating devices, depending upon the size of the part and the equipment available.

It does no good to heat a part, then let it cool before welding. Always be sure the area to be surfaced is at the specified temperature when starting to weld.

Checking the temperature of the part during welding may be needed to be sure it has not cooled. More heating may be needed if welding is stopped for lunch or any other reason.

Interpass temperature is the temperature of the surface when welding all layers except the first layer. It is just as important and should usually be as high as the preheat temperature. **NEVER OVERHEAT MANGANESE STEEL. KEEP INTERPASS TEMPERATURES BELOW 500°F (260°C).**

Pattern of Deposit

Although the pattern is usually not important, here are a few general rules:

1. The best pattern is usually the one most economical to apply.
2. Since pattern affects shrinkage stresses, it can be used to help control distortion and cracking tendencies.
3. A pattern with openings between beads is practical when the openings fill with the abrasive material in service.
4. On jobs like crusher rolls, beads placed on the rolls across the flow of material help pull the material through the rolls.
5. Beads placed parallel to the flow of abrasive material smooth the flow to reduce wear.

Buildup

Badly worn surfaces are normally rebuilt to within 3/16-3/8" (4.8mm-9.5mm) of original size before hardfacing. Buildup carbon or low alloy steel with Wearshield BU, Wearshield BU30 or Lincore 33 or with L-60 and H535 submerged arc flux using low alloy procedure guides. Rebuild manganese steel with either Wearshield Mangjet or Lincore M.

Admixture and Cooling Rate

Small beads made with small electrodes and low currents have fast cooling rates and low admixture of base metal into weld metal. Using two layers reduces admixture in the final layer.

Welding Edges

Molten metal, slag, and granular submerged arc flux tends to spill off the edges particularly when the part is hot. Eliminate spillage by surfacing the edges first before the part becomes hot or else clamp copper bars or flux dams along the edges. Run beads along the edge rather than perpendicular to it for smooth welds.

To Obtain the Desired Wear Resistance, Control Alloy Content and Cooling Rate

How to Control Alloy Content

Carbon and alloy content are controlled by both procedures and admixture. Admixture of the electrode metal to the base plate has a very important effect on the wear resistance of the weld deposit. Effective weld metal composition is listed for deposits having the recommended number of weld passes. Lincore self-shielded wires and Wearshield stick electrodes produce consistent weld metal composition despite procedure variations within full normal ranges. A single layer of a highly abrasion resistant material, like Wearshield 60 or Lincore 60-O will not be nearly as abrasion resistant (due to dilution) as a second layer.

How to Control Cooling Rate

Although cooling rate affects wear resistance of some deposits, it is much more important for the control of spalling, cracking and distortion. Therefore, a slow cooling rate may be required even if it reduces wear resistance.

Methods of controlling cooling rate include the following:

1. Preheating is the most effective way of slowing the cooling rate.
2. Heat input from welding slows cooling by raising the temperature of the part.
3. Insulating the hot part immediately after welding with dry sand, lime, glass fiber blanket, etc. slows cooling. This method helps minimize residual cooling stresses, weld cracking and distortion but does not affect wear resistance of most deposits. Remember also, large parts pull heat away from the weld more quickly than small parts. They naturally cool the weld faster.

To Avoid Weld Spalling

Spalling is the breaking of weld metal particles away from the base metal or previous hardfacing layers. Particle size varies from small chips to large pieces right down to the base metal. Spalling normally occurs only in service. To avoid spalling:

1. Prepare the Surface: As in production welding, hardfacing welds must have a sound crack-free bond with the base metal. Therefore, clean the surface and repair cracks and surface damage.
2. Avoid Underbead Cracking: Rapid cooling from welding temperature can cause brittle, crack-sensitive, heat-affected zones in some types of base metal. These zones tend to crack in service causing spalling. To avoid this problem, preheat as specified.
3. Apply a layer of austenite before depositing hardfacing. This can be Type 309 stainless or highly alloyed austenitic manganese, such as Wearshield 15CrMn, Wearshield 22Mn5Cr, Lincore 15CrMn or Lincore 22Mn5Cr. Standard austenitic manganese, such as Wearshield Mangjet or Lincore M, may not provide enough alloy for austenite in a single layer over carbon or low alloy steel.
4. Limit Deposit Thickness: Thick hardfacing deposits build up shrinkage stresses resulting in a greater tendency for spalling. Do not use more hardfacing layers than specified for each type deposit. If thicker deposits are required, utilize more buildup before hardfacing. Peen each layer of thick buildup deposits to relieve stresses.

To Avoid Underbead Cracking

Underbead cracks are small cracks that can occur in the heat affected zone of the base metal under the weld. The cracks do not usually show on the surface, but can cause spalling or cracking of the part in service.

Occurrence of underbead cracking depends primarily upon the carbon and alloy content of the base metal. See following text for specific preheat recommendations. Use of the non-low hydrogen electrodes — Wearshield 60, Wearshield ABR and Wearshield MM — may require 100-300°F (40-150°C) higher preheat than the other Lincoln buildup or hardfacing materials. However, welding with these electrodes on hot buildup layers usually eliminates potential problems.

The easiest way to prevent underbead cracking is to slow the cooling rate by preheating. Always be sure the part is at least up to room temperature [70-100°F (20-40°C)] before welding. Use higher preheats if specified for your particular base metal below. When the base metal analysis is known, you can determine recommended preheat more closely using the Preheat Calculator available from the Lincoln Electric Company.

Completing all buildup and hardfacing without long delays is recommended to keep the part hot. This minimizes danger of cracking and eliminates need for additional preheating.

Submerged arc welding, particularly with the Spreadarc attachment, is a high heat input process. It heats the part, slows the cooling rate and reduces underbead cracking problems. Spreadarc is not recommended on manganese steel.

Low Carbon Steel: to 0.30%C approx.

1. Slightly hardenable. Preheat 70-300°F (21-149°C).
2. Preheat heavy parts of over .20%C to 200-300°F (93-149°C). Use the higher temperature for massive, rigid or complex parts.

Medium Carbon Steel: 0.30 to 0.45%C approx.

1. Moderately hardenable, especially in large parts and heavy sections. Preheat to 300-500°F (149-260°C). Use the higher temperature for higher carbon contents and for large, rigid or complex parts.

High Carbon Steel: over 0.45%C approx.

1. Highly hardenable and crack sensitive in all sizes and shapes. Preheat to 500-800°F (260-427°C). Use the higher temperatures for the higher carbon contents and for large, rigid or complex shapes.
2. When carbon content is near .80%, deposit a buttering layer with Excalibur 7018 or a mild steel submerged arc flux and electrode prior to depositing buildup or hardfacing layers. The buttering layer minimizes underbead cracking danger and provides a good bond between base metal and hardfacing deposits.

Low Alloy Steel:

1. Varies from medium hardenable to highly hardenable depending upon carbon and alloy content. Preheat to 100-500°F (38-260°C). Use the higher temperatures for higher carbon and alloy contents and for large, rigid or complex shapes.
2. Preheat temperatures up to 800°F (427°C) or a buttering layer may be required if the carbon content is over .35%C.

Manganese Steel: 12-14% Manganese

1. Not hardenable or crack-sensitive. Preheat is not required for thinner sections.
2. Preheat massive or highly rigid parts to 100-200°F (38-93°C). Prolonged heating over 500°F (260°C) can cause embrittlement of the manganese steel.
3. On small parts, avoid high localized heating by using a skip welding technique.

Cast Iron

1. Extremely crack sensitive. The heat affected zone may be full of cracks even with preheat temperatures of 1200-1400°F (650-760°C). Therefore, hardfacing cast iron is often uneconomical. If it must be welded, follow the standard cast iron welding precautions in Lincoln **Publication C8.10**.

To Avoid Stress Failure of the Part

Some parts contain high retained internal stresses. When the welding stresses are added to these retained stresses, the part can break. This is stress failure.

Such failure can occur near the weld or at any weak point in the part. Look for this possibility when hardfacing the following types of parts:

- a. Highly rigid parts. Massive parts and complex shapes are inherently rigid.
- b. Shrink-fit parts.
- c. Some large castings, particularly when they are made of medium to high carbon steel or medium carbon low alloy steels.
- d. Parts hardened by heat treatment.

Stress failure can be avoided with the following steps:

1. Preheat slowly to the high side of the temperature range as previously specified for the particular type of base metal. As much as possible, this preheat should be uniform throughout the part.
 - a. Shrink-fit parts must be preheated to expand them until they are loose. Manganese steel requires a lower temperature because it has a high coefficient of expansion.
 - b. Parts which were hardened by heat treatment should be pack or controlled atmosphere annealed. Slow cool until the specified preheat temperature is reached.
2. Arrange the welding schedule so it can be completed without any interruptions.
3. The part should be slowly and uniformly cooled. This can be done by covering the part with a glass fiber blanket or some other insulating material or by cooling in a furnace.

To Avoid Weld Cracking

Products Designed for Build-Up

Lincoln hardfacing products designed for buildup applications have good resistance to cross cracking and are not restricted with regard to deposit thickness. These products include Wearshield BU, Lincore M, Lincore 30-S with 801 flux, Lincore 33, Wearshield 15CrMn, Lincore 15CrMn and H-535/L-60 (low alloy procedure), A-96S/L-60 and A-100/L-60 electrodes.

Special precautions, however, should be taken with any buildup or hardfacing product on applications that are inherently crack sensitive. These applications include the surfacing of high carbon or alloy steels, previously surfaced parts and highly stressed parts. The surfacing of heavy cylinders, massive parts and parts having complex shapes are all examples of applications producing high internal stresses that may result in delayed cracking.

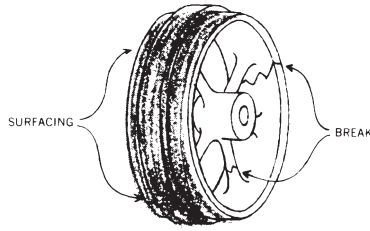

Complex shape is inherently rigid. Preheat to prevent stress failure at any weak point.

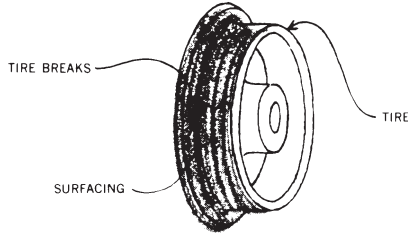

Shrink-fit tire — Expand by preheating to prevent stress failure.

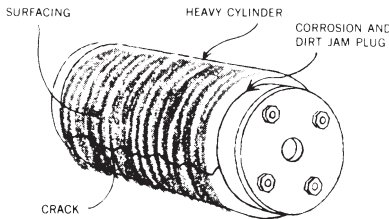

Crusher roll — Loosen through bolts and expand the roll with preheat to loosen plugs.

Longitudinal or Center-line Cracking

This cracking is associated with poor bead shape. It is caused by too flat a bead, that is, a high ratio of bead width to bead height. If center-line cracking is a problem:

- When welding with stick or Lincore flux-cored electrodes, use a stringer bead or minimum weaving technique and low current.
- Be sure fillet welds are slightly convex.
- In submerged arc surfacing when using Spreadarc attachment, center-line cracking does not often occur. This is because the high heat input of the process assures sufficiently slow cooling.
- In other submerged arc jobs this cracking can sometimes occur. If it does, decrease the step-over (or increase the bead overlap) enough to remelt the center of the previous bead, or adjust bead shape.
- For submerged arc jobs on roundabouts, be sure you set the correct electrode displacement distance and angle as specified in circumferential sub-arc hardfacing.

To Avoid Distortion Problems

Distortion in welding is caused principally by the unbalanced stresses which result from the expansion of the metal during heating and contraction during cooling. These stresses and their effects are uneven both in strength and direction. They depend on many factors.

In many cases the small amount of resultant distortion does not affect the performance of the part. Consequently, no more precaution than clamping the part in position for welding is needed.

In some cases the part is hardfaced oversize to allow for the distortion. It is then machined or ground to size. This method is most often used on parts which must be machined or ground to finish before using.

In some cases the part is allowed to distort, and it is straightened while still hot enough to bend without cracking.

In those cases where the distortion will ruin the usability of the part, the distortion forces must be controlled. Use one or a combination of the following methods. Generally, a study of the part to be surfaced and the equipment available will determine the best method to use.

Methods of Controlling Distortion:

- Preforming — Use with flat pieces and other relatively thin and simply shaped parts.
 - Bend, form, or clamp the part with the proper preset before welding. The distortion forces will then pull the part back to its original shape.
- Counterbalance the stresses — Use with parts which cannot be straightened after welding. Be sure the increased rigidity will not cause underbead cracking.
 - Weld or clamp two similar parts back to back. Alternate the welding from one part to the other.
 - Weld or clamp the part to a strongback, fixture or platen.
- Limit the temperature of the part — This is an effective method particularly when high rigidity can cause cracking.
 - Distribute the heat evenly by first welding one area, then welding a different area as the first cools.
 - Reduce the heat input by using a procedure with low current.
 - Remove some of the heat by blowing air, circulating water through the part, or clamping a water-cooled copper jacket to the part.

These applications may require one or more of the following precautions:

- Higher preheat temperature [400-500°F (200-260°C)].
- Higher interpass temperatures.
- Controlled slow cooling between passes and/or layers and after completion of the welding.
- Minimizing layer thickness.

Very severely stressed parts may require an intermittent or final drawing operation at 800-900°F (427-482°C).

Transverse or Cross Cracking

- The third and sometimes the second Wearshield ABR or Lincore 50 layer and all "Severe Abrasion" type deposits are designed to cross crack. This is beneficial because the cracking relieves stresses which can otherwise cause spalling or distortion. This cross cracking does not harm the wear resistance of the deposit.
- In other types of deposits, cross cracking can be a problem. It generally occurs in parts which are massive, rigid or of complex shape. If this cross cracking must be minimized, preheat to 1200°F (650°C). The preheating found necessary to prevent underbead or stress failure cracking will also minimize weld cross cracking.

- d. Substitute properly welded inserts rather than making thick welds.
- 4. Relieve the stresses — Stress relieve very large parts, rigid shapes, shrink-fit parts, and other highly stressed pieces.
 - a. Peen each layer during cooling. This is most effective with “Severe Impact” and “Abrasion-plus-Impact” type deposits.
 - b. Preheat the entire part slowly and uniformly to expand the part prior to welding. Generally 150-200°F (66-93°C) is sufficient for manganese steel. Preheat carbon or low alloy steel to 300-500°F (149-260°C).
- 5. Cross-Cracking Deposit — The “Severe Abrasion” type deposits are designed to cross crack on cooling. These cracks minimize distortion by relieving the stresses.

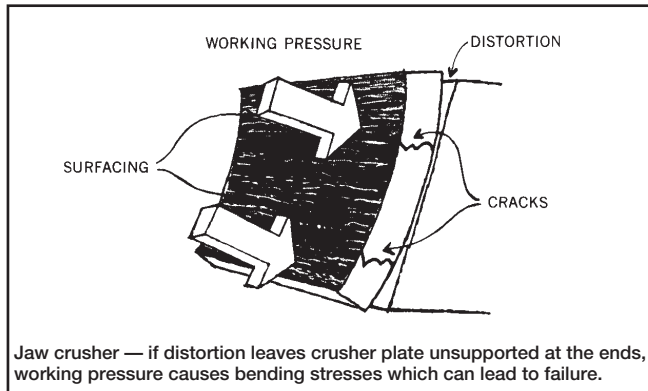

General Welding Procedures

Manual Covered Electrodes - Table 1

Electrode Size In (mm)	3/32 (2.4)	1/8 (3.2)	5/32 (4.0)	3/16 (4.8)	1/4 (6.4)
DC+/AC (Amps)	80-100	90-165	140-220	175-260	210-325
Deposition Rate Lb/Hr (kg/hr)	1.2-2.0 (.54-.90)	2.1-2.8 (.95-1.3)	2.7-3.8 (1.2-1.7)	3.7-5.0 (1.7-2.3)	4.9-6.9 (2.2-3.1)

There is an optimum current for every application. Use the above listed guide to find the best setting for a particular Wearshield electrode and application.

Wearshield hardfacing electrodes may be used on flat, vertical and sometimes overhead surfaces. In the flat position, the excellent Wearshield arc operation will permit weaving the electrode up to 1/2 inch (12.7mm) wide. When welding on vertical surfaces, deposit a stringer bead along the bottom of the area to be surfaced and build on that bead to cover the entire surface. Overhead applications require smaller diameter electrode, low operating currents and special welding techniques to prevent weld metal dripping. Wide weaves are not recommended with any hardfacing electrodes and in particular, not with manganese steel electrodes or base metals.

As in any type welding, proper plate preparation is necessary for good results.

Small diameter electrodes and low currents are recommended when welding on manganese steel castings. Procedures and techniques that will prevent overheating the manganese base plate are necessary to prevent cracking spalling, and embrittlement.

Lincore Open Arc Self-Shielded Electrodes

Typical Parameters Table 2

Direct Current Electrode Positive (DC+)⁽¹⁾

Electrode Size	.045" (1.1 mm)	1/16" (1.6 mm)	5/64" (2.0 mm)	7/64" (2.8 mm)
WFS in/min (m/min)	200-600 (5.1-15.2)	150-450 (3.8-11.4)	125-250 (3.2-6.4)	90-175 (2.3-4.4)
Amps	85-250	125-350	190-400	280-420
Volts	21-31	24-33	25-32	26-32
ESO Inches (mm)	3/4-1 1/8 (19-29)	7/8-1 3/4 (22-45)	1 1/4-1 3/4 (32-45)	1 1/2-2 3/4 (38-70)
Deposition Rate Lb/Hr (kg/hr)	3.6-12.3 (1.5-5.6)	4.8-16.6 (2.2-7.5)	7.0-15.1 (3.2-6.9)	8.4-16.5 (3.8-7.5)
Melt-Off Rate Lb/Hr (kg/hr)	4.3-13.1 (2.0-5.9)	5.9-17.4 (2.7-7.9)	8.0-15.8 (3.6-7.2)	10.6-19.6 (4.8-8.9)

⁽¹⁾ Constant voltage power supplies are recommended but constant current may also be used.

Table 2 lists typical parameters for the Lincore Open Arc Electrodes. Individual electrode sheets contain precise information relative to procedure and deposition rates. Small diameter Lincore semiautomatic electrodes can be used on vertical surfaces by depositing a stringer bead along the bottom of the area to be surfaced. A copper chill bar may be necessary to support this bead. Subsequent beads are deposited along the previous bead top surface until the area to be surfaced is covered.

Lincore semiautomatic electrodes are designed for optimum operator appeal and require no external shielding. It is possible to use these electrodes with Lincolnweld 801 flux for a further reduction in smoke and spatter.

Lincore Open Arc Self-Shielded Electrodes Operating Characteristics - Table 3

When Lincore electrodes are used properly, the resulting smooth, uniform weld bead is fully covered (except Lincore 50, 60-O and 65-O), with easily removed slag and deposition rates are significantly higher than with manual (stick) welding.

Wire Feed Speed (Amps) Increasing	Increases Deposition Rate Increases Penetration Increases Heat Input
Voltage Increasing	Wider and Flatten Bead Excessive Voltage Results in Porosity
Electrical Stickout (ESO) Increasing Decreasing	Increases Melt-Off Rate Excessively Long Stickout Results in Increased Spatter Excessively Short Stickout Results in Porosity

Lincore Submerged Arc Electrodes Typical Parameters - Table 4

A good starting point for general operating procedures when welding with submerged arc flux and the Lincore electrodes would be in the middle of the operating range.

Electrode Size	3/32" (2.4 mm)	1/8" (3.2 mm)	5/32" (4.0 mm)
WFS in/min m/min	50-140 (1.3-3.6)	48-90 (1.2-2.3)	40-65 (1.0-1.7)
Amps	250-450	350-625	475-800
Volts	25-28	26-30	26-30
ESO Inches (mm)	1-1/4 (32)	1-1/2 (38)	1-1/2 (38)
Deposition Rate Lb/Hr (kg/hr)	6.5-17.5 (2.9-8.0)	9.5-22.1 (4.3-10.0)	13.1-27.3 (6.0-12.4)
Melt-Off Rate Lb/Hr (kg/hr)	6.6-17.8 (3.0-8.1)	9.7-22.6 (4.4-10.3)	13.4-27.9 (6.1-12.7)

Lincore Submerged Arc Electrodes Electrode Sizes/Deposition Rates - Table 5

Change the parameters as suggested in Table 3 for individual applications. Using the maximum wire feed speed (amps) within the limits of good weld bead shape will result in the highest deposition rate and the most economical welding procedure.

Diameter In (mm)	WFS In/min (m/min)	Approx. (Amps)	Volts	ESO In. (mm)	Travel Speed In/min (m/min)
3/32 (2.4)	120 (3.0)	375	26	1-1/4 (32)	15-25 (.4-.6)
1/8 (3.2)	100 (2.5)	500	27	1-1/2 (38.5)	15-25 (.4-.6)
5/32 (4.0)	85 (2.2)	650	28	1-1/2 (38.5)	15-25 (.4-.6)

Circumferential Submerged Arc Hardfacing

For a thorough description of circumferential submerged arc welding, refer to Lincoln **Publication C5.630**.

In circumferential hardfacing, 3 inch (76mm) diameter and larger cylindrical objects are rotated under the welding head. The welds differ from those made in the flat position in that the flux and molten metal tends to sag or spill off the work.

To prevent spilling or bead distortion, the weld must freeze as it passes the vertical center of the work. This requires the proper electrode displacement distance as listed in Table 6 and the proper wire feed speed and voltage from Table 4. Speed must also be controlled to make small beads of the proper shape.

A faster, smaller bead tends to freeze quicker than a slow bead.

Temperature Control

The temperature of the work should be kept below 700°F (370°C) for easy slag removal and control of spilling. In addition to depositing small beads and using air jets or internal water cooling (when practical), temperature can be controlled by depositing a stringer bead.

Approximate
Displacement (d)
of the electrode

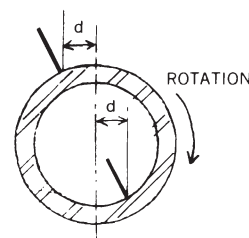

Table 6

Girth Diameter In (mm)	Electrode Position "d" (Inches ahead of vertical center) In (mm)
3-18 (76-457)	3/4-1 (19-25)
18-36 (457-914)	1-1/4-1-1/2 (31-38)
36-48 (914-1219)	1-1/2-2 (38-51)
48-72 (1219-1828)	2-2-1/2 (51-63)
over 72 (1824)	3 (76)

The serviceability of a product or structure utilizing this type of information is and must be the sole responsibility of the builder/user. Many variables beyond the control of The Lincoln Electric Company affect the results obtained in applying this type of information. These variables include, but are not limited to, welding procedure, plate chemistry and temperature, weldment design, fabrication methods and service requirements.

Overlap

The amount one bead overlaps the adjacent bead affects both admixture of base metal into weld metal — greater overlap reduces admixture — and appearance of the finished weld. Control overlap by adjusting the amount of longitudinal travel with each revolution.

Longitudinal travel is accomplished either by spiraling the bead or indexing the welding head across the work after each complete revolution (stepover). Unless a lathe with a slow screw feed mechanism or a very low speed travel carriage is available, the stepover method is recommended.

For automatic stepover, mount a limit switch that is operated by a cam type trip on the rotating fixture. Connect the limit switch into the travel carriage motor circuit so the motor runs when the switch is operated. The distance moved is controlled by the size of the cam and speed of the travel motor. A time delay can be used in place of the cam. Slag must be removed before each bead makes a complete revolution.

Overlap Welding Currents & Voltages

Diameter in. (mm)	Current
3-6 (76-152)	250-350 amps ⁽¹⁾
6-12 (76-304)	300-400 amps
12-18 (304-457)	350-500 amps
over 18 (457)	Standard hardfacing procedures (single electrode or twin arc).

⁽¹⁾ Voltage Range is 24-32 volts.

Neutral Hardfacing Flux Characteristics

Lincolnweld® 880 — Light in color, fine mesh size most economical. Use with most hardfacing semiautomatic and automatic Lincore electrodes.

Lincolnweld 801 — Darker in color, larger mesh size. Use with most hardfacing semiautomatic and automatic Lincore electrodes.

Lincolnweld 802 — Use with electrodes containing Ti, V, Cb, Mo or W alloys. May be used in place of 801 flux.

Lincolnweld 803 — Use with Lincore 60-S.

Certain fluxes, described as "neutral" with regard to mild steel and low alloy steel joining, are not neutral when used with Lincore hardfacing electrodes. Some fluxes can remove considerable carbon and/or chromium, and produce weld metal of less than optimum composition and wear resistance.

If in doubt, ask! Call your Lincoln Representative or The Lincoln Electric Weld Technology Department, in Cleveland, Ohio at (216) 383-4760.

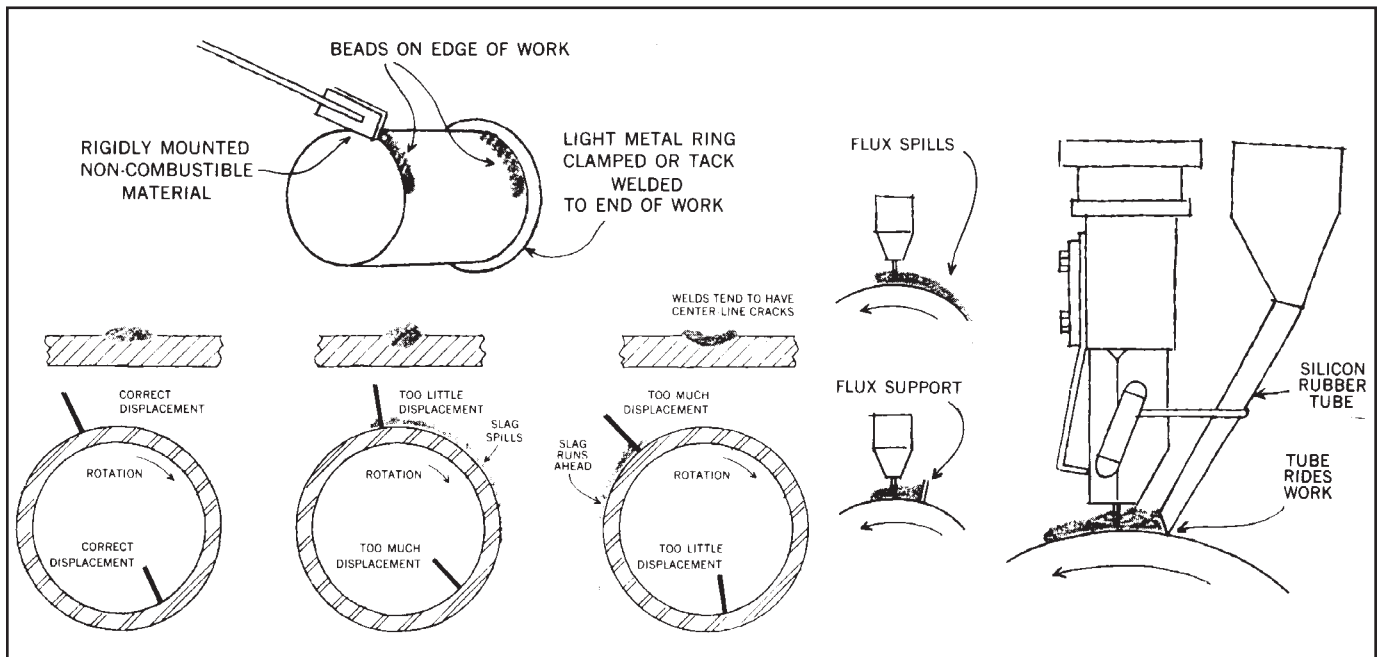

Preheat Recommendation Chart

Steel Group	Steel Designation	Carbon	Preheat-°F.(°C)(a)	
			Base Metal 4" thick	
Carbon Steels	AISI-SAE	1015	.13-.18	150° (66°)
		1020	.18-.23	150° (66°)
		1030	.28-.34	200° (93°)
		1040	.37-.44	300° (149°)
		1080	.75-.88	600° (316°)
Manganese Steels	AISI-SAE	1330	.28-.33	250° (121°)
		1335	.33-.38	300° (149°)
		1340	.38-.43	350° (177°)
		1345	.43-.48	400° (204°)
		1345H	.42-.49	400° (204°)
Molybdenum Steels	AISI-SAE	4027H	.24-.30	250° (121°)
		4032H	.29-.35	300° (149°)
		4037H	.34-.41	350° (177°)
		4042H	.39-.46	400° (204°)
		4047H	.44-.51	450° (232°)
Chrome Molybdenum Steels	AISI-SAE	4118	.17-.23	250° (121°)
		4130	.27-.34	300° (149°)
		4135	.32-.39	400° (204°)
		4145	.41-.49	500° (260°)
		4145H	.42-.49	500° (260°)
Ni-Chrome Molybdenum And Ni-Moly. Steels	AISI-SAE	4340	.38-.43	500° (260°)
		4615	.18-.18	250° (121°)
		4620	.17-.22	250° (121°)
		4720H	.17-.23	300° (149°)
		4820H	.17-.23	300° (149°)

Steel Group	Steel Designation	Carbon	Preheat°F.(°C)(a)	
			Base Metal 4" thick	
Chromium Steels	AISI-SAE	5015	.12-.17	200° (93°)
		5046	.43-.48	450° (232°)
		5115	.13-.18	200° (93°)
		5145	.43-.48	450° (232°)
		5160	.56-.64	550° (288°)
Austenitic Manganese And Chrome-Ni. Steels (b)	ASTM	11-14% Mn	.5-1.3	Preheat only to remove chill from base metal
		302	.15 Max.	
		309	.20 Max.	
		310	.25 Max.	
		347	.08 Max.	
Carbon Steel Plate Structural Quality	ASTM	A36	.27 Max.	250° (121°)
		A131 Gr.B	.21 Max.	200° (93°)
		A284 Gr.C	.29 Max.	250° (121°)
		A678 Gr.B (c)	.20 Max.	200° (93°)
High Strength Low Alloy Steels Structural Quality	ASTM	A131-H.S.	.18 Max.	350° (177°)
		A242 Type 2	.20 Max.	200° (93°)
		A441	.22 Max.	200° (93°)
		A588 Gr.B	.20 Max.	300° (149°)
		A633 Gr.E	.22 Max.	250° (121°)
Alloy And Pressure Vessel Quality Steels	ASTM	A514 Gr.F (c)	.10-.21	350° (177°)
		A514 Gr.H (c)	.12-.21	300° (149°)
		A514 Gr.Q (c)	.14-.21	550° (288°)
		A515 Gr.70	.35 Max.	300° (149°)
		A516 Gr.70	.30 Max.	250° (121°)

(a) These suggested preheats are recommended when Low Hydrogen processes are used on base metals that are 4" thick. Lower preheats could be used on thinner material while higher preheats would be necessary on thicker materials. When using non-Low Hydrogen processes increase suggested preheats by 300°F (149°C).

The steels shown on the chart are only partially representative of the steels used in the manufacture of earth moving and other machinery. A Preheat Calculator available from The Lincoln Electric Co. makes it possible to figure suggested preheats for other steels based upon the chemistry of the steel and the thickness of the parts to be surfaced.

(b) It is sometimes advisable to preheat large, thick 11 to 14% Manganese parts prior to welding. Use a maximum of 200°F. preheat. (Do not exceed 500°F (260°C) interpass temperature). Check base metal with magnet. 11 to 14% Manganese and the ASTM 300 series of chrome-nickel steels are **NOT** magnetic.

(c) Q & T Steels

Customer Assistance Policy

The business of The Lincoln Electric Company is manufacturing and selling high quality welding equipment, consumables, and cutting equipment. Our challenge is to meet the needs of our customers and to exceed their expectations. On occasion, purchasers may ask Lincoln Electric for advice or information about their use of our products. We respond to our customers based on the best information in our possession at that time. Lincoln Electric is not in a position to warrant or guarantee such advice, and assumes no liability, with respect to such information or advice. We expressly disclaim any warranty of any kind, including any warranty of fitness for any customer's particular purpose, with respect to such information or advice. As a matter of practical consideration, we also cannot assume any responsibility for updating or correcting any such information or advice once it has been given, nor does the provision of information or advice create, expand or alter any warranty with respect to the sale of our products.

Lincoln Electric is a responsive manufacturer, but the selection and use of specific products sold by Lincoln Electric is solely within the control of, and remains the sole responsibility of the customer. Many variables beyond the control of Lincoln Electric affect the results obtained in applying these type of fabrication methods and service requirements.

Equipment for Hardfacing

Cost-saving Lincoln equipment is designed to give long life with minimum maintenance. Lincoln has full automatic systems for high volume or long-running jobs, completely portable semiautomatics for the shop or field and stick welding equipment where maximum flexibility is required. Power sources include both electric and engine driven units. Additional detailed information and specifications can be obtained from bulletins identified below each product.

Contact your Lincoln Representative or your authorized Lincoln Distributor for these bulletins and for further details.

Air Vantage® 500
Request Bulletin E6.217

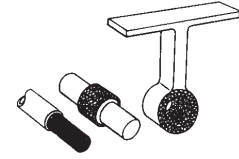

Vantage® 300
Request Bulletin E6.206



The Ranger® 10,000
Request Bulletin E6.92

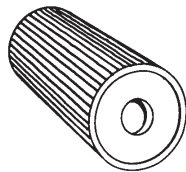

Ranger® 305D
Request Bulletin E6.118

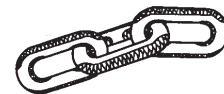

DISTRIBUTED BY:

LINCOLN®
ELECTRIC

THE WELDING EXPERTS

THE LINCOLN ELECTRIC COMPANY
22801 St. Clair Ave.
Cleveland, Ohio 44117-1199

TEL: 216.481.8100 • FAX: 216.486.1751

www.lincolnelectric.com

Hardfacing
C7.710 1/05